

# » User Guide «

## **CP-RIO6-001-HD-VGA**

### **6U CompactPCI Rear Transition Module**

Doc. ID: 1052-4138, Rev. 1.0  
July 30, 2012



## Revision History

Publication Title:		CP-RIO6-001-HD-VGA 6U CompactPCI Rear Transition Modules
Doc. ID:		1052-4138
Rev.	Brief Description of Changes	Date of Issue
1.0	Initial issue	30-Jul-2012

## Imprint

Kontron Europe GmbH may be contacted via the following:

**MAILING ADDRESS**

Kontron Europe GmbH  
 Sudetenstraße 7  
 D - 87600 Kaufbeuren Germany

**TELEPHONE AND E-MAIL**

+49 (0) 800-SALESKONTRON  
 sales@kontron.com

For further information about other Kontron products, please visit our Internet web site: [www.kontron.com](http://www.kontron.com).

## Disclaimer

Copyright © 2012 Kontron AG. All rights reserved. All data is for information purposes only and not guaranteed for legal purposes. Information has been carefully checked and is believed to be accurate; however, no responsibility is assumed for inaccuracies. Kontron and the Kontron logo and all other trademarks or registered trademarks are the property of their respective owners and are recognized. Specifications are subject to change without notice.





## Table of Contents

<i>Revision History</i> .....	<i>ii</i>
<i>Imprint</i> .....	<i>ii</i>
<i>Disclaimer</i> .....	<i>ii</i>
<i>Table of Contents</i> .....	<i>iii</i>
<i>List of Tables</i> .....	<i>v</i>
<i>List of Figures</i> .....	<i>vii</i>
<i>Proprietary Note</i> .....	<i>ix</i>
<i>Trademarks</i> .....	<i>ix</i>
<i>Environmental Protection Statement</i> .....	<i>ix</i>
<i>Explanation of Symbols</i> .....	<i>x</i>
<i>For Your Safety</i> .....	<i>xi</i>
<i>High Voltage Safety Instructions</i> .....	<i>xi</i>
<i>Special Handling and Unpacking Instructions</i> .....	<i>xi</i>
<i>General Instructions on Usage</i> .....	<i>xii</i>
<i>Two Year Warranty</i> .....	<i>xiii</i>
<b>1. Introduction</b> .....	<b>1 - 3</b>
1.1 <i>Board Overview</i> .....	1 - 3
1.2 <i>Board Diagrams</i> .....	1 - 3
1.2.1 <i>Functional Block Diagram</i> .....	1 - 3
1.2.2 <i>Front Panel</i> .....	1 - 4
1.2.3 <i>Board Layout</i> .....	1 - 5
1.3 <i>Technical Specification</i> .....	1 - 6
1.4 <i>Standards</i> .....	1 - 7
1.5 <i>Related Publications</i> .....	1 - 8
<b>2. Functional Description</b> .....	<b>2 - 3</b>
2.1 <i>Board Interfaces</i> .....	2 - 3
2.1.1 <i>USB Interfaces</i> .....	2 - 3
2.1.1.1 <i>Front Panel USB Connectors J16 and J17</i> .....	2 - 3
2.1.1.2 <i>Onboard USB NAND Flash Connector J14</i> .....	2 - 4
2.1.2 <i>VGA Interface</i> .....	2 - 5
2.1.3 <i>Gigabit Ethernet Interfaces</i> .....	2 - 6



2.1.4	Serial ATA Interfaces .....	2 - 7
2.1.4.1	SATA Connector J13 .....	2 - 7
2.1.4.2	SATA Connector J15 .....	2 - 8
2.1.5	COM Interfaces .....	2 - 9
2.1.5.1	COMA Port .....	2 - 9
2.1.5.2	COMB Port .....	2 - 10
2.1.6	FAN Connectors .....	2 - 10
2.1.7	Rear I/O Interface on cPCI Connectors: rJ3, rJ4 and rJ5 .....	2 - 11
2.1.8	GPIO Connectors J10 and J11 .....	2 - 15
2.2	System Write Protection Jumper J12 .....	2 - 15

**3. Installation ..... 3 - 3**

3.1	Safety Requirements .....	3 - 3
3.2	Rear I/O Module Installation Procedures .....	3 - 4
3.3	Rear I/O Module Removal Procedures .....	3 - 5
3.4	Installation of Peripheral Devices .....	3 - 5
3.4.1	USB Device Installation .....	3 - 5
3.4.2	USB 2.0 NAND Flash Module Installation .....	3 - 6
3.4.3	Installation of an External Serial ATA Device .....	3 - 6
3.4.4	Installation of a 2.5" SATA HDD/SSD Device .....	3 - 7





## List of Tables

1-1	<i>CP-RIO6-001-HD-VGA Main Specifications</i> .....	1 - 6
1-2	<i>Standards for the CP-RIO6-001-HD-VGA</i> .....	1 - 7
1-3	<i>Related Publications</i> .....	1 - 8
2-1	<i>USB Con. J16 and J17 Pinout</i> .....	2 - 3
2-2	<i>USB NAND Flash Con. J14 Pinout</i> .....	2 - 4
2-3	<i>D-Sub VGA Connector J20 Pinout</i> .....	2 - 5
2-4	<i>Pinout of Dual GbE Connector J18A/B</i> .....	2 - 6
2-5	<i>SATA Connector J13 Pinout</i> .....	2 - 7
2-6	<i>SATA Connector J15 Pinout</i> .....	2 - 8
2-6	<i>Serial Con. J19 (COMA) Pinout</i> .....	2 - 9
2-7	<i>Serial Port Connector J8 (RS-232/RS-422) Pinout</i> .....	2 - 10
2-8	<i>Fan Control Con. J6 and J7 Pinout</i> .....	2 - 10
2-10	<i>Rear I/O CompactPCI Connector rJ3 Signals</i> .....	2 - 12
2-9	<i>Rear I/O CompactPCI Connector rJ3 Pinout</i> .....	2 - 12
2-11	<i>Rear I/O CompactPCI Connector rJ4 Pinout</i> .....	2 - 13
2-13	<i>Rear I/O CompactPCI Rear I/O Connector rJ5 Signals</i> .....	2 - 14
2-12	<i>Rear I/O CompactPCI Connector rJ5 Pinout</i> .....	2 - 14
2-14	<i>J12 Jumper Setting for System Write Protection</i> .....	2 - 15



This page has been intentionally left blank.





## List of Figures

1-1	<i>CP-RIO6-001-HD-VGA Functional Block Diagram</i> .....	1 - 3
1-2	<i>CP-RIO6-001-HD-VGA Front Panel</i> .....	1 - 4
1-3	<i>CP-RIO6-001-HD-VGA Board Layout – Front View</i> .....	1 - 5
2-1	<i>USB Con. J16 and J17</i> .....	2 - 3
2-2	<i>USB NAND Flash Con. J14</i> .....	2 - 4
2-3	<i>D-Sub VGA Connector J20</i> .....	2 - 5
2-4	<i>Dual Gigabit Ethernet Con. J18A/B</i> .....	2 - 6
2-5	<i>SATA Con. J13</i> .....	2 - 7
2-6	<i>SATA Connector J15</i> .....	2 - 8
2-7	<i>Serial Con. J19 (COMA)</i> .....	2 - 9
2-8	<i>Serial Port Connector J8</i> .....	2 - 10
2-9	<i>Fan Control Con. J6 and J7</i> .....	2 - 10
2-10	<i>Rear I/O CompactPCI Connectors rJ3, rJ4 and rJ5</i> .....	2 - 11
3-1	<i>Placement of the Onboard Mass Storage Devices</i> .....	3 - 7



This page has been intentionally left blank.







## Proprietary Note

This document contains information proprietary to Kontron. It may not be copied or transmitted by any means, disclosed to others, or stored in any retrieval system or media without the prior written consent of Kontron or one of its authorized agents.

The information contained in this document is, to the best of our knowledge, entirely correct. However, Kontron cannot accept liability for any inaccuracies or the consequences thereof, or for any liability arising from the use or application of any circuit, product, or example shown in this document.

Kontron reserves the right to change, modify, or improve this document or the product described herein, as seen fit by Kontron without further notice.

## Trademarks

Kontron, the *PEP* logo and, if occurring in this manual, “CXM” are trademarks owned by Kontron, Kaufbeuren (Germany). In addition, this document may include names, company logos and trademarks, which are registered trademarks and, therefore, proprietary to their respective owners.

## Environmental Protection Statement

This product has been manufactured to satisfy environmental protection requirements where possible. Many of the components used (structural parts, printed circuit boards, connectors, batteries, etc.) are capable of being recycled.

Final disposition of this product after its service life must be accomplished in accordance with applicable country, state, or local laws or regulations.



## Explanation of Symbols



### ***Caution, Electric Shock!***

This symbol and title warn of hazards due to electrical shocks (> 60V) when touching products or parts of them. Failure to observe the precautions indicated and/or prescribed by the law may endanger your life/health and/or result in damage to your material.

Please refer also to the section “High Voltage Safety Instructions” on the following page.



### ***Warning, ESD Sensitive Device!***

This symbol and title inform that electronic boards and their components are sensitive to static electricity. Therefore, care must be taken during all handling operations and inspections of this product, in order to ensure product integrity at all times.

Please read also the section “Special Handling and Unpacking Instructions” on the following page.



### ***Warning!***

This symbol and title emphasize points which, if not fully understood and taken into consideration by the reader, may endanger your health and/or result in damage to your material.



### ***Note ...***

This symbol and title emphasize aspects the reader should read through carefully for his or her own advantage.



## For Your Safety

Your new Kontron product was developed and tested carefully to provide all features necessary to ensure its compliance with electrical safety requirements. It was also designed for a long fault-free life. However, the life expectancy of your product can be drastically reduced by improper treatment during unpacking and installation. Therefore, in the interest of your own safety and of the correct operation of your new Kontron product, you are requested to conform with the following guidelines.

### High Voltage Safety Instructions



#### **Warning!**

All operations on this device must be carried out by sufficiently skilled personnel only.



#### **Caution, Electric Shock!**

Before installing a not hot-swappable Kontron product into a system always ensure that your mains power is switched off. This applies also to the installation of piggybacks.

Serious electrical shock hazards can exist during all installation, repair and maintenance operations with this product. Therefore, always unplug the power cable and any other cables which provide external voltages before performing work.

### Special Handling and Unpacking Instructions



#### **ESD Sensitive Device!**

Electronic boards and their components are sensitive to static electricity. Therefore, care must be taken during all handling operations and inspections of this product, in order to ensure product integrity at all times.

Do not handle this product out of its protective enclosure while it is not used for operational purposes unless it is otherwise protected.

Whenever possible, unpack or pack this product only at EOS/ESD safe work stations. Where a safe work station is not guaranteed, it is important for the user to be electrically discharged before touching the product with his/her hands or tools. This is most easily done by touching a metal part of your system housing.

It is particularly important to observe standard anti-static precautions when changing piggybacks, ROM devices, jumper settings etc. If the product contains batteries for RTC or memory backup, ensure that the board is not placed on conductive surfaces, including anti-static plastics or sponges. They can cause short circuits and damage the batteries or conductive circuits on the board.



---

## General Instructions on Usage

In order to maintain Kontron's product warranty, this product must not be altered or modified in any way. Changes or modifications to the device, which are not explicitly approved by Kontron and described in this manual or received from Kontron's Technical Support as a special handling instruction, will void your warranty.

This device should only be installed in or connected to systems that fulfill all necessary technical and specific environmental requirements. This applies also to the operational temperature range of the specific board version, which must not be exceeded. If batteries are present, their temperature restrictions must be taken into account.

In performing all necessary installation and application operations, please follow only the instructions supplied by the present manual.

Keep all the original packaging material for future storage or warranty shipments. If it is necessary to store or ship the board, please re-pack it as nearly as possible in the manner in which it was delivered.

Special care is necessary when handling or unpacking the product. Please consult the special handling and unpacking instruction on the previous page of this manual.



## Two Year Warranty

Kontron grants the original purchaser of Kontron's products a ***TWO YEAR LIMITED HARDWARE WARRANTY*** as described in the following. However, no other warranties that may be granted or implied by anyone on behalf of Kontron are valid unless the consumer has the express written consent of Kontron.

Kontron warrants their own products, excluding software, to be free from manufacturing and material defects for a period of 24 consecutive months from the date of purchase. This warranty is not transferable nor extendible to cover any other users or long-term storage of the product. It does not cover products which have been modified, altered or repaired by any other party than Kontron or their authorized agents. Furthermore, any product which has been, or is suspected of being damaged as a result of negligence, improper use, incorrect handling, servicing or maintenance, or which has been damaged as a result of excessive current/voltage or temperature, or which has had its serial number(s), any other markings or parts thereof altered, defaced or removed will also be excluded from this warranty.

If the customer's eligibility for warranty has not been voided, in the event of any claim, he may return the product at the earliest possible convenience to the original place of purchase, together with a copy of the original document of purchase, a full description of the application the product is used on and a description of the defect. Pack the product in such a way as to ensure safe transportation (see our safety instructions).

Kontron provides for repair or replacement of any part, assembly or sub-assembly at their own discretion, or to refund the original cost of purchase, if appropriate. In the event of repair, refunding or replacement of any part, the ownership of the removed or replaced parts reverts to Kontron, and the remaining part of the original guarantee, or any new guarantee to cover the repaired or replaced items, will be transferred to cover the new or repaired items. Any extensions to the original guarantee are considered gestures of goodwill, and will be defined in the "Repair Report" issued by Kontron with the repaired or replaced item.

Kontron will not accept liability for any further claims resulting directly or indirectly from any warranty claim, other than the above specified repair, replacement or refunding. In particular, all claims for damage to any system or process in which the product was employed, or any loss incurred as a result of the product not functioning at any given time, are excluded. The extent of Kontron liability to the customer shall not exceed the original purchase price of the item for which the claim exists.

Kontron issues no warranty or representation, either explicit or implicit, with respect to its products' reliability, fitness, quality, marketability or ability to fulfil any particular application or purpose. As a result, the products are sold "as is," and the responsibility to ensure their suitability for any given task remains that of the purchaser. In no event will Kontron be liable for direct, indirect or consequential damages resulting from the use of our hardware or software products, or documentation, even if Kontron were advised of the possibility of such claims prior to the purchase of the product or during any period since the date of its purchase.

Please remember that no Kontron employee, dealer or agent is authorized to make any modification or addition to the above specified terms, either verbally or in any other form, written or electronically transmitted, without the company's consent.



This page has been intentionally left blank.





*Chapter*

**1**

---

# Introduction

---



This page has been intentionally left blank.







# 1. Introduction

## 1.1 Board Overview

The CP-RIO6-001-HD-VGA is a 6U CompactPCI rear transition module designed for use with Kontron 6U CompactPCI CPU boards and provide comprehensive rear I/O functionality for peripherals. In order to use these modules, a special 6U CompactPCI backplane with rear I/O support as well as a compatible and correctly configured CPU board are required.

The CP-RIO6-001-HD-VGA comes with three USB 2.0 ports, two Gigabit Ethernet ports with LED signals, one VGA port, two onboard SATA ports, two onboard COM ports and two onboard fan connectors.

## 1.2 Board Diagrams

The following diagrams provide additional information concerning the boards' functionality and component layout.

### 1.2.1 Functional Block Diagram

Figure 1-1: CP-RIO6-001-HD-VGA Functional Block Diagram

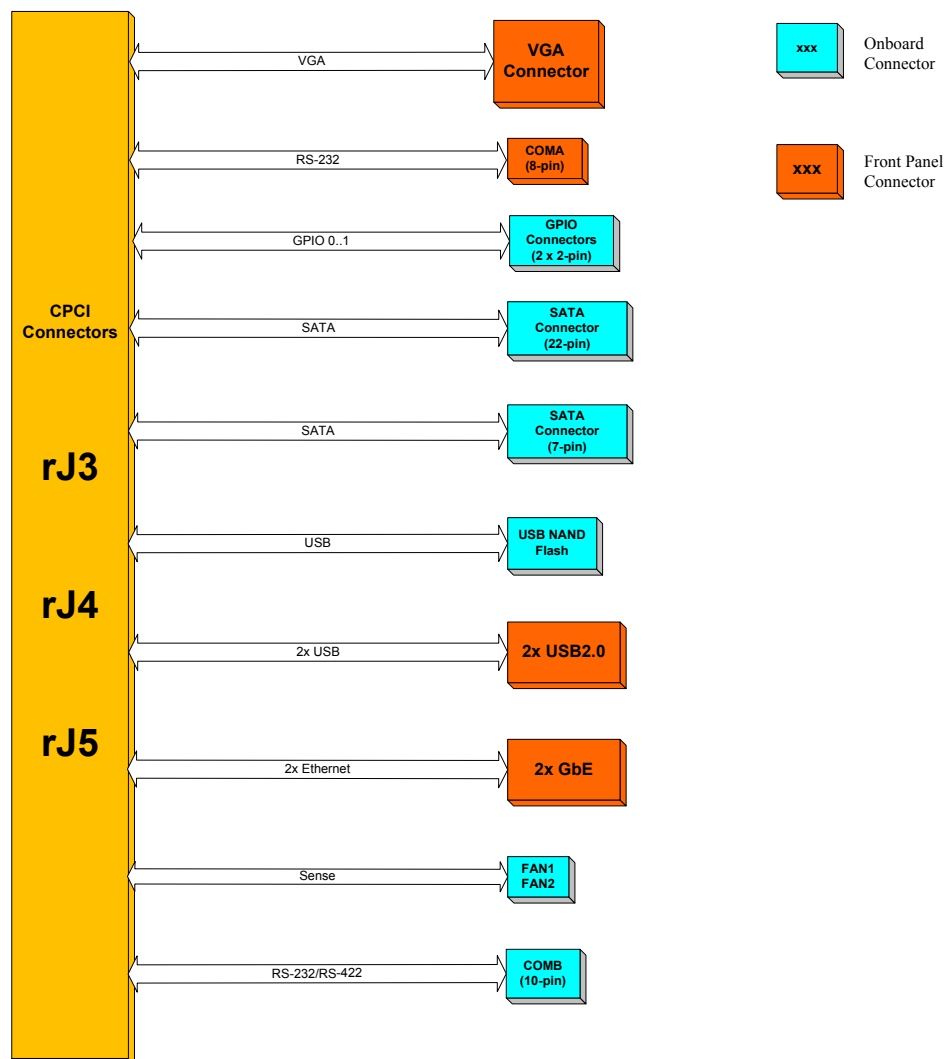



1.2.2 Front Panel

Figure 1-2: CP-RIO6-001-HD-VGA Front Panel

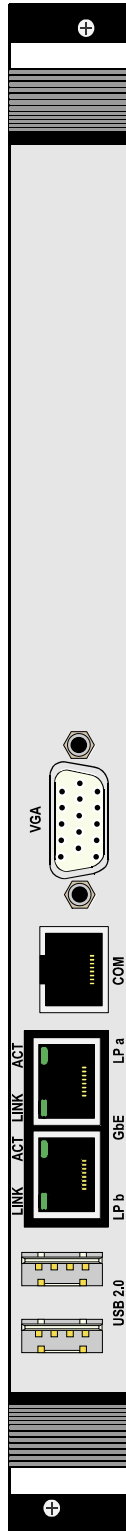



### 1.2.3 Board Layout

Figure 1-3: CP-RIO6-001-HD-VGA Board Layout – Front View

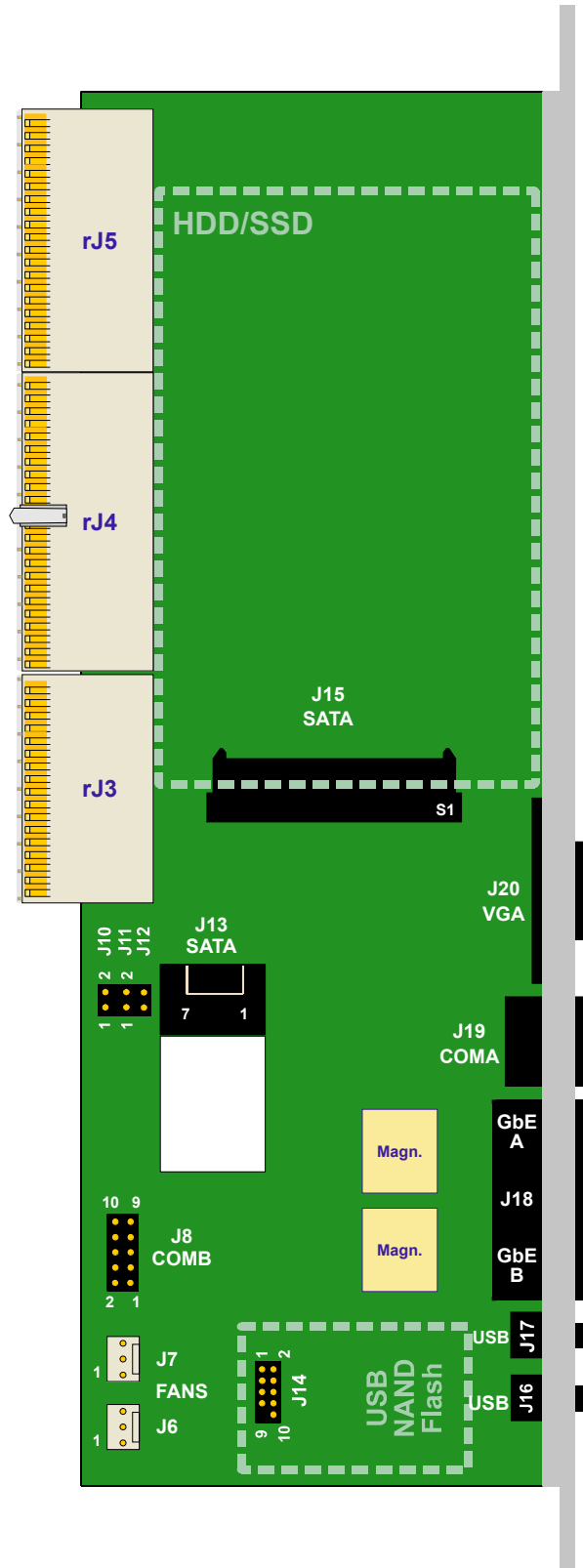

## 1.3 Technical Specification

Table 1-1: CP-RIO6-001-HD-VGA Main Specifications

CP-RIO6-001-HD-VGA		SPECIFICATIONS
Front Panel Interfaces	Analog Video	VGA: 15-pin, D-Sub connector, J20
	Ethernet	Two Gigabit Ethernet interfaces implemented as a dual RJ-45 connector, J18A/B
	USB	Two USB 2.0 interfaces on type A connectors, J16 and J17
	COM	One COM interface implemented as a single RJ45 connector, J19
Onboard Interfaces	SATA	Two SATA interfaces implemented as two onboard connectors: <ul style="list-style-type: none"> <li>• One SATA connector, J13, for connecting a SATA device via a SATA cable</li> <li>• One SATA connector, J15, for installing an optional 2.5" SATA HDD/SSD</li> </ul>
	USB	One onboard connector, J14, for connecting one USB 2.0 NAND Flash module
	COM	One COM port implemented as one 10-pin, 2.54 mm onboard connector, J8
	Fan	Two fan connectors, J6 and J7, with sense inputs for monitoring the fan speed
	CompactPCI	Three CompactPCI connectors, rJ3, rJ4 and rJ5, for connecting the module to the backplane
	GPIO	Two GPIO interfaces on the two-pin connectors J10 and J11
General	Temperature Range	Operational: 0°C to +60°C Standard -40°C to +85°C E2 (optional) Storage: -55°C to +85°C Without any additional components  <p><b>Note ...</b>            When additional components are installed, refer to their operational specifications as this will influence the modules' operational and storage temperature.</p>
	Mechanical	6U, 4HP, CompactPCI-compliant form factor
	Dimensions	233.35 mm x 80 mm
	Board Weight	228 g (without USB NAND Flash module and/or HDD/SSD)

## 1.4 Standards

The CP-RIO6-001-HD-VGA complies with the requirements of the following standards:

**Table 1-2: Standards for the CP-RIO6-001-HD-VGA**

TYPE	ASPECT	STANDARD	REMARKS
CE	Emission	EN55022 EN61000-6-3	--
	Immission	EN55024 EN61000-6-2	--
	Electrical Safety	EN60950-1	--
Mechanical	Mechanical Dimensions	IEEE 1101.10	--
Environmental	Climatic Humidity	IEC60068-2-78	93% RH at 40°C, non-condensing
	WEEE	Directive 2002/96/EC	Waste electrical and electronic equipment
	RoHS	Directive 2002/95/EC	Restriction of the use of certain hazardous substances in electrical and electronic equipment
	Vibration (Sinusoidal)	IEC60068-2-6	Ruggedized version test parameters: <ul style="list-style-type: none"> <li>• 10-300 (Hz) frequency range</li> <li>• 2 (g) acceleration</li> <li>• 1 (oct/min) sweep rate</li> <li>• 10 cycles/axis</li> <li>• 3 axes</li> </ul>
	Single Shock	IEC60068-2-27	Ruggedized version test parameters: <ul style="list-style-type: none"> <li>• 30 (g) acceleration</li> <li>• 9 (ms) shock duration half sine</li> <li>• 3 number of shocks per direction (total: 18)</li> <li>• 6 directions</li> <li>• 5 (s) recovery time</li> </ul>
	Permanent Shock	IEC60068-2-29	Ruggedized version test parameters: <ul style="list-style-type: none"> <li>• 15 (g) acceleration</li> <li>• 11 (ms) shock duration half sine</li> <li>• 500 number of shocks per direction</li> <li>• 6 directions</li> <li>• 1 (s) recovery time</li> </ul>

**Note ...**

Kontron performs comprehensive environmental testing of its products in accordance with applicable standards.

Customers desiring to perform further environmental testing of Kontron products must contact Kontron for assistance prior to performing any such testing. This is necessary, as it is possible that environmental testing can be destructive when not performed in accordance with the applicable specifications.

In particular, for example, boards **without conformal coating** must not be exposed to a change of temperature exceeding 1K/minute, averaged over a period of not more than five minutes. Otherwise, condensation may cause irreversible damage, especially when the board is powered up again.

Kontron does not accept any responsibility for damage to products resulting from destructive environmental testing.

## 1.5 Related Publications

The following publications contain information relating to the CP-RIO6-001-HD-VGA.

**Table 1-3: Related Publications**

PRODUCT	PUBLICATION
CompactPCI Systems and Boards	CompactPCI Specification 2.0, Rev. 3.0
	<i>Kontron CompactPCI Backplane Manual</i> , ID 24229
All Kontron products	Product Safety and Implementation Guide, ID 1021-9142



*Chapter* **2**

---

# Functional Description

---



This page has been intentionally left blank.







## 2. Functional Description

### 2.1 Board Interfaces

#### 2.1.1 USB Interfaces

The CP-RIO6-001-HD-VGA rear I/O module supports three USB 2.0 ports, two on the front I/O and one onboard for the USB NAND Flash module. All ports are high-speed, full-speed, and low-speed capable. One USB peripheral may be connected to each port. For connecting more USB devices to the CP-RIO6-001-HD-VGA than there are available ports, an external USB hub is required.



**Note ...**

The USB host interfaces can be used with maximum 500 mA continuous load current as specified in the Universal Serial Bus Specification, Revision 2.0. Short-circuit protection is provided. All the signal lines are EMI-filtered.



**Note ...**

The rear I/O interface supports the USB 1.1 and USB 2.0 standards. For USB 2.0 it is strongly recommended to use a cable length not exceeding 3 meters.

#### 2.1.1.1 Front Panel USB Connectors J16 and J17

On the front panel of the CP-RIO6-001-HD-VGA rear I/O module, there are two USB interfaces implemented on two 4-pin connectors with the following pinout:

**Figure 2-1: USB Con. J16 and J17**

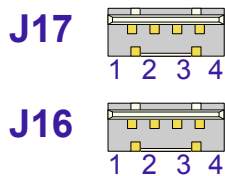

**Table 2-1: USB Con. J16 and J17 Pinout**

PIN	SIGNAL	FUNCTION	I/O
1	VCC	VCC	--
2	UV0-	Differential USB-	I/O
3	UV0+	Differential USB+	I/O
4	GND	GND	--



## 2.1.1.2 Onboard USB NAND Flash Connector J14

The CP-RIO6-001-HD-VGA rear I/O module has one onboard USB interface implemented on a 9-pin connector, J14, with the following pinout.

**Figure 2-2: USB NAND Flash Con. J14**    **Table 2-2: USB NAND Flash Con. J14 Pinout**



PIN	SIGNAL	FUNCTION	I/O
1	VCC	VCC	--
3	UV0-	Differential USB-	I/O
5	UV0+	Differential USB+	I/O
7	GND	GND	--
9	Key		
2, 4, 6, 8	NC	Not connected	--
10	Res.	Reserved	--

The J14 connector is used to connect an optional USB 2.0 NAND Flash module qualified by Kontron. The USB 2.0 NAND Flash module is a USB 2.0-based NAND Flash drive with a built-in full hard-disk emulation and a high data transfer rate. It is optimized for embedded systems providing high performance, reliability and security.



### Note ...

Only qualified USB 2.0 NAND Flash modules from Kontron are authorized for use with the CP-RIO6-001-HD-VGA. Use of unqualified USB 2.0 NAND Flash modules or improper installation will void the warranty and may result in damage to the CP-RIO6-001-HD-VGA or the system.





### 2.1.2 VGA Interface

The CP-RIO6-001-HD-VGA provides one 15-pin, female connector, J20, on the front panel. This connector is used to connect an analog VGA (CRT) monitor to the module.

The following figure illustrates the D-Sub VGA connector J20.

**Figure 2-3: D-Sub VGA Connector J20**

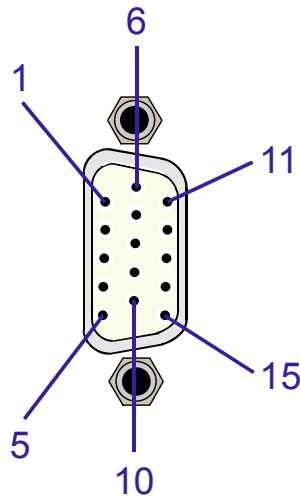

The following table indicates the pinout of the D-Sub VGA connector J20.

**Table 2-3: D-Sub VGA Connector J20 Pinout**

PIN	SIGNAL	FUNCTION	I/O
1	Red	Red video signal output	O
2	Green	Green video signal output	O
3	Blue	Blue video signal output	O
4	NC	Not connected	--
5 - 8	GND	Signal ground	--
9	VCC	Power +5V, 0.5 A fuse protection	O
10	GND	Signal ground	--
11	NC	Not connected	--
12	SDA	I <sup>2</sup> C data (EDID)	I/O
13	Hsync	Horizontal synchronization	TTL Out
14	Vsync	Vertical synchronization	TTL Out
15	SCL	I <sup>2</sup> C clock (EDID)	I/O



## 2.1.3 Gigabit Ethernet Interfaces

The CP-RIO6-001-HD-VGA provides a Gigabit Ethernet interface implemented as one dual, RJ-45 Ethernet connector J18A/B.

**Figure 2-4: Dual Gigabit Ethernet Con. J18A/B**

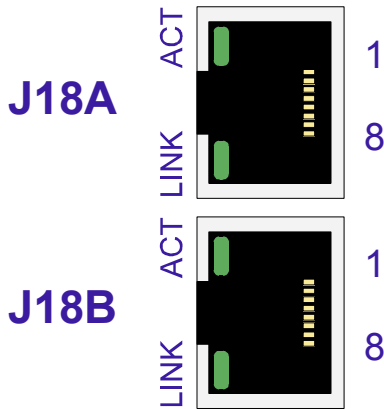

**Table 2-4: Pinout of Dual GbE Connector J18A/B**

PIN	MDI / STANDARD ETHERNET CABLE					
	10BASE-T		100BASE-TX		1000BASE-T	
	I/O	SIGNAL	I/O	SIGNAL	I/O	SIGNAL
1	0	TX+	0	TX+	I/O	BI_DA+
2	0	TX-	0	TX-	I/O	BI_DA-
3	1	RX+	1	RX+	I/O	BI_DB+
4	-	-	-	-	I/O	BI_DC+
5	-	-	-	-	I/O	BI_DC-
6	1	RX-	1	RX-	I/O	BI_DB-
7	-	-	-	-	I/O	BI_DD+
8	-	-	-	-	I/O	BI_DD-



**Note ...**

The Ethernet transmission can operate effectively with structured cable that meets CAT5 cable or higher specifications.

### Ethernet LED Status

**ACT (green):** This LED monitors network connection and activity. When this LED is lit, it means that a link has been established. The LED blinks when network packets are sent or received through the RJ-45 port. When this LED is not lit, there is no link established.

**LINK (green):** This LED lights up to indicate a successful 100Base-TX connection. When not lit and the ACT-LED is active, the connection is operating at 1000Base-T or 10Base-T.





**2.1.4 Serial ATA Interfaces**

The CP-RIO6-001-HD-VGA provides two SATA interfaces, one for connecting a standard 2.5" SATA HDD/SSD and one for connecting a SATA device via a SATA cable.

The SATA interfaces are capable of supporting SATA 1.5 Gb/s and SATA 3.0 Gb/s signaling.

**2.1.4.1 SATA Connector J13**

The CP-RIO6-001-HD-VGA rear I/O module is equipped with a SATA connector, J13, used to connect a standard SATA device to the rear I/O module via a SATA cable. The rear I/O module will not exceed the thickness of 4HP when a Serial ATA cable is used.

The following figure and table provide pinout information for the SATA connector J13.

**Figure 2-5: SATA Con. J13**

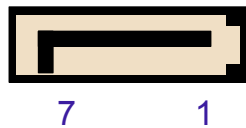

**Table 2-5: SATA Connector J13 Pinout**

PIN	SIGNAL	DESCRIPTION	I/O
1	GND	Ground signal	--
2	SATA_TX+	Differential Transmit +	0
3	SATA_TX-	Differential Transmit -	0
4	GND	Ground signal	--
5	SATA_RX-	Differential Receive -	1
6	SATA_RX+	Differential Receive +	1
7	GND	Ground signal	--



**Note ...**

To ensure secure connectivity, the SATA connector supports the use of SATA cables with a locking latch.



## 2.1.4.2 SATA Connector J15

The CP-RIO6-001-HD-VGA rear I/O module is equipped with the SATA connector J15 used to connect a 2.5" SATA HDD/SSD to the rear I/O module. The connector is divided into two segments, a signal segment and a power segment.

Figure 2-6: SATA Connector J15

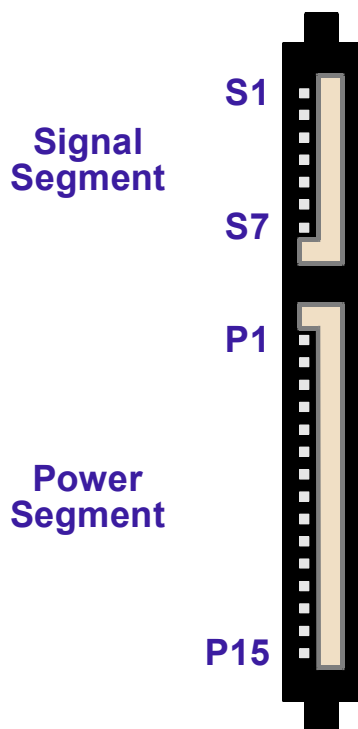

Table 2-6: SATA Connector J15 Pinout

PIN	SIGNAL	FUNCTION	I/O
Signal Segment Key			
S1	GND	Ground signal	--
S2	SATA_TX+	Differential Transmit+	I
S3	SATA_TX-	Differential Transmit-	I
S4	GND	Ground signal	--
S5	SATA_RX-	Differential Receive-	O
S6	SATA_RX+	Differential Receive+	O
S7	GND	Ground signal	--
Signal Segment "L"			
Central Connector Polarizer			
Power Segment "L"			
P1	3.3V	3.3V power	--
P2	3.3V	3.3V power	--
P3	3.3V	3.3V power	--
P4	GND	Ground signal	--
P5	GND	Ground signal	--
P6	GND	Ground signal	--
P7	5V	5V power	--
P8	5V	5V power	--
P9	5V	5V power	--
P10	GND	Ground signal	--
P11	RES	Reserved	--
P12	GND	Ground signal	--
P13	12V	12 V power	--
P14	12V	12 V power	--
P15	12V	12 V power	--
Power Segment Key			



### 2.1.5 COM Interfaces

The CP-RIO6-001-HD-VGA rear I/O module provides two COM ports for connecting RS-232 (COMA) and RS-232/RS-422 (COMB) devices, depending on the CPU board. The following figures and tables provide pinout information for the COM connector J8 (COM B) and J19 (COMA).

#### 2.1.5.1 COMA Port

The COMA port is available on the front panel as a serial RS-232, 8-pin, RJ-45 connector

**Figure 2-7: Serial Con. J19 (COMA)**

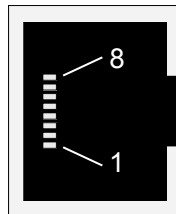

**Table 2-6: Serial Con. J19 (COMA) Pinout**

PIN	SIGNAL	FUNCTION	I/O
1	RTS	Request to send	O
2	DTR	Data terminal ready	O
3	TXD	Transmit data	O
4	GND	Signal ground	--
5	GND	Signal ground	--
6	RXD	Receive data	I
7	DSR	Data set ready	I
8	CTS	Clear to send	I



### 2.1.5.2 COMB Port

The COMB port is realized using an onboard 10-pin male header type connector, J8.

Figure 2-8: Serial Port Connector J8

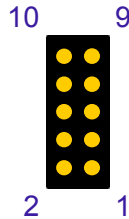

Table 2-7: Serial Port Connector J8 (RS-232/RS-422) Pinout

RS-232 SIGNALING			PIN	RS-422 SIGNALING		
I/O	DESCRIPTION	SIGNAL		SIGNAL	DESCRIPTION	I/O
I	Data carrier detect	DCD	1	RX+	Receive data +	I
I	Data send request	DSR	2	RX-	Receive data -	I
I	Receive data	RXD	3	NC	Not connected	--
O	Request to send	RTS	4	NC	Not connected	--
O	Transmit data	TXD	5	TX+	Transmit data +	O
I	Clear to send	CTS	6	TX-	Transmit data -	O
O	Data terminal ready	DTR	7	NC	Not connected	--
I	Ring indicator	RI	8	NC	Not connected	--
--	Signal ground	GND	9	GND	Signal ground	--
--	Not connected	NC	10	NC	Not connected	--

### 2.1.6 FAN Connectors

The CP-RIO6-001-HD-VGA has two 3-pin, onboard fan connectors, J6 and J7, used to connect two external cooling fans.

Figure 2-9: Fan Control Con. J6 and J7

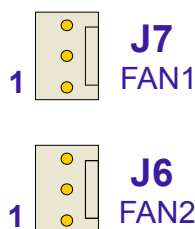

Table 2-8: Fan Control Con. J6 and J7 Pinout

PIN	SIGNAL	DESCRIPTION	I/O
1	GND	Signal ground	--
2	PWM	Fan Supply Voltage (12V)	O
3	SENSE	Fan Sense	I



**Note ...**

The maximum allowable continuous load current on each fan interface is 300 mA.





**2.1.7 Rear I/O Interface on cPCI Connectors: rJ3, rJ4 and rJ5**

The CP-RIO6-001-HD-VGA rear I/O module is equipped with three CompactPCI rear I/O connectors: rJ3, rJ4 and rJ5.



**Note ...**

To support the rear I/O feature, a 6U CompactPCI backplane with rear I/O support as well as a compatible and correctly configured CPU board are required. Do not plug the CP-RIO6-001-HD-VGA in a backplane without rear I/O support. Failure to comply with the above will result in damage to the CP-RIO6-001-HD-VGA.

**Figure 2-10: Rear I/O CompactPCI Connectors rJ3, rJ4 and rJ5**

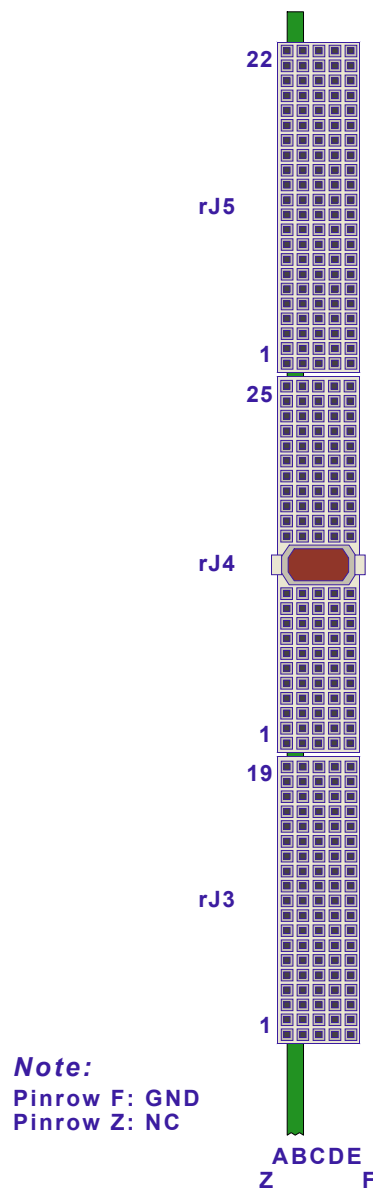



**Table 2-9: Rear I/O CompactPCI Connector rJ3 Pinout**

PIN	Z	A	B	C	D	E	F
19	NC	RIO_VCC	RIO_VCC	RIO_3.3V	RIO_+12V	RIO_-12V	GND
18	NC	LPa_DA+	LPa_DA-	GND	LPa_DC+	LPa_DC-	GND
17	NC	LPa_DB+	LPa_DB-	GND	LPa_DD+	LPa_DD-	GND
16	NC	LPb_DA+	LPb_DA-	GND	LPb_DC+	LPb_DC-	GND
15	NC	LPb_DB+	LPb_DB-	GND	LPb_DD+	LPb_DD-	GND
14	NC	LPa:LINK	LPb:LINK	NC	NC	FAN:SENSE2	GND
13	NC	LPa:ACT	LPb:ACT	NC	NC	FAN:SENSE1	GND
12	NC	NC	NC	GND	NC	NC	GND
11	NC	NC	NC	GND	NC	NC	GND
10	NC	USB1:VCC	USB0:VCC	GND	RSV	USB2:VCC	GND
9	NC	USB1:D-	USB1:D+	GND	RSV	RSV	GND
8	NC	USB0:D-	USB0:D+	GND	USB2:D-	USB2:D+	GND
7	NC	RIO_3.3V	GPIO: *	GPIO: *	GPIO: *	NC	GND
6	NC	VGA:RED	VGA:GREEN	VGA:SD1	RSV	NC	GND
5	NC	VGA:BLUE	VGA:HSYNC	VGA:VSYNC	VGA:SCL	NC	GND
4	NC	SPB:RI SPB:NC	SPB:DTR SPB:NC	SPB:CTS SPB:TX-	SPB:TX SPB:TX+	NC	GND
3	NC	SPB:RTS SPB:NC	SPB:RX SPB:NC	SPB:DSR SPB:RX-	SPB:DCD SPB:RX+	NC	GND
2	NC	SPA:RI	SPA:DTR	SPA:CTS	SPA:TX	NC	GND
1	NC	SPA:RTS	SPA:RX	SPA:DSR	SPA:DCD	ID1	GND



**Warning!**

The RIO\_XXX signals are power supply **INPUTS** to supply the rear I/O module with power from the CPU board. These pins **MUST NOT** be connected to any other power source, either within the backplane itself or within a rear I/O module.

Failure to comply with the above will result in damage to your board.

The following table describes the signals of the rJ3 connector used on the CP-RIO6-001-HD-VGA.

**Table 2-10: Rear I/O CompactPCI Connector rJ3 Signals**

SIGNAL	DESCRIPTION	SIGNAL	DESCRIPTION
SPA	COMA Signaling RS-232	LPb	Rear I/O LAN Port A
SPB	COMB Signaling RS-232/RS-422	VGA	Analog Video Signaling
USB0 to USB2	USB Port Signaling	FAN	Fan Sensoring
GPIO: *	General Purpose IO Signaling: on request only (direction depends on CPU board functionality)		
LPa	Rear I/O LAN Port B		

Table 2-11: Rear I/O CompactPCI Connector rJ4 Pinout

PIN	Z	A	B	C	D	E	F
25	NC	RSV	RSV	GND	RSV	RSV	GND
24	NC	RSV	RSV	GND	RSV	RSV	GND
23	NC	NC	RIO_VCC	GND	NC	RIO_3.3V	GND
22	NC	RSV	RSV	GND	RSV	RSV	GND
21	NC	RSV	RSV	GND	RSV	RSV	GND
20	NC	GND	GND	GND	GND	GND	GND
19	NC	RSV	RSV	GND	RSV	RSV	GND
18	NC	RSV	RSV	GND	RSV	RSV	GND
17	NC	GND	GND	GND	GND	GND	GND
16	NC	RSV	RSV	GND	RSV	RSV	GND
15	NC	RSV	RSV	GND	RSV	RSV	GND
12-14	Key Area						
11	NC	RSV	RSV	GND	RSV	RSV	GND
10	NC	RSV	RSV	GND	RSV	RSV	GND
9	NC	GND	GND	GND	GND	GND	GND
8	NC	RSV	RSV	GND	RSV	RSV	GND
7	NC	RSV	RSV	GND	RSV	RSV	GND
6	NC	GND	GND	GND	GND	GND	GND
5	NC	RSV	RSV	GND	RSV	RSV	GND
4	NC	RSV	RSV	GND	RSV	RSV	GND
3	NC	GND	GND	GND	GND	GND	GND
2	NC	RSV	RSV	GND	RSV	RSV	GND
1	NC	RSV	RSV	GND	RSV	RSV	GND

**Warning!**

The RIO\_XXX signals are power supply **INPUTS** to supply the rear I/O module with power from the CPU board. These pins **MUST NOT** be connected to any other power source, either within the backplane itself or within a rear I/O module.

Failure to comply with the above will result in damage to your board.



**Table 2-12: Rear I/O CompactPCI Connector rJ5 Pinout**

PIN	Z	A	B	C	D	E	F
22	NC	GPIO: *	PWM1:OUT	GND	PWM2:OUT	NC	GND
21	NC	NC	NC	GND	NC	SYS_WP	GND
20	NC	GPIO:0	NC	GND	GPIO:1	NC	GND
19	NC	GND	GND	GND	NC	NC	GND
18	NC	NC	NC	GND	GND	GND	GND
17	NC	NC	NC	GND	NC	NC	GND
16	NC	NC	NC	GND	GPIO: *	GPIO: *	GND
15	NC	NC	NC	GND	NC	NC	GND
14	NC	GND	GND	GND	GND	GND	GND
13	NC	NC	NC	NC	NC	NC	GND
12	NC	NC	NC	NC	NC	NC	GND
11	NC	NC	NC	NC	NC	NC	GND
10	NC	NC	NC	NC	NC	NC	GND
9	NC	GND	GND	GND	GND	GND	GND
8	NC	SATA3:TX+	SATA3:TX-	GND	SATA3:RX+	SATA3:RX-	GND
7	NC	GND	GND	GND	GND	GND	GND
6	NC	RSV	RSV	GND	RSV	RSV	GND
5	NC	GND	GND	GND	GND	GND	GND
4	NC	SATA1:TX+	SATA1:TX-	GND	SATA1:RX+	SATA1:RX-	GND
3	NC	GND	GND	GND	GND	GND	GND
2	NC	RSV	RSV	GND	RSV	RSV	GND
1	NC	GND	GND	GND	GND	GND	GND

The following table describes the signals of the rJ5 connector.

**Table 2-13: Rear I/O CompactPCI Rear I/O Connector rJ5 Signals**

SIGNAL	DESCRIPTION
SATA1 and SATA3	SATA Port 1 and Port 3 Signaling
GPIO	General Purpose IO Signaling (direction and voltage leveling depends on CPU board functionality)
GPIO *	General Purpose IO Signaling: on request only (direction and voltage leveling depends on CPU board functionality)
PWM	Pulse width modulation output for fan





### 2.1.8 GPIO Connectors J10 and J11

The CP-RIO6-001-HD-VGA has two GPIO interfaces, one on J10 (GPIO:0) and one on J11 (GPIO:1). Pin 1 is the signal and pin 2 is ground. Refer to figure 1-3 for the connector locations and pin orientation.

Signal direction, input or output and voltage leveling is a function of the CPU. Filtering and signal protection must be done by the system integrator.

## 2.2 System Write Protection Jumper J12

When set, this jumper signals the host CPU to invoke system write protection. If this protection is required, please contact Kontron before implementing.

**Table 2-14: J12 Jumper Setting for System Write Protection**

J12	DESCRIPTION
<i>Open</i>	<i>System Write Protection not enabled</i>
Closed	System Write Protection enabled

The default setting is indicated by using italic bold.



This page has been intentionally left blank.





*Chapter* **3**

---

# Installation

---



This page has been intentionally left blank.







### 3. Installation

The CP-RIO6-001-HD-VGA has been designed for easy installation. However, the following standard precautions, installation procedures, and general information must be observed to ensure proper installation and to preclude damage to the CP-RIO6-001-HD-VGA, other system components, or injury to personnel.

#### 3.1 Safety Requirements

The following safety precautions must be observed when installing or operating the CP-RIO6-001-HD-VGA. Kontron assumes no responsibility for any damage resulting from failure to comply with these requirements.



**Caution!**

Ensure that the system main power is removed prior to installing or removing the CP-RIO6-001-HD-VGA. Ensure that there are no other external voltages or signals being applied to the CP-RIO6-001-HD-VGA or other boards within the system. Failure to do so could endanger your life or health and may damage the CP-RIO6-001-HD-VGA or other system components including process-side signal conditioning equipment.



**ESD Equipment!**

The CP-RIO6-001-HD-VGA contains electrostatically sensitive devices. Please observe the necessary precautions to avoid damage to the CP-RIO6-001-HD-VGA:

- Discharge your clothing before touching the assembly. Tools must be discharged before use.
- Do not touch components, connector-pins or traces.
- If working at an anti-static workbench with professional discharging equipment, please do not omit to use it.



## 3.2 Rear I/O Module Installation Procedures

To perform an installation of the rear I/O module in a system, proceed as follows:

1. Ensure that the safety requirements indicated Chapter 3.1 are observed.



### **Warning!**

Failure to comply with the instruction below may cause damage to the rear I/O module or result in improper system operation.

2. Ensure that the rear I/O module is compatible with the CPU board and the backplane prior to installation.



### **Note ...**

Ensure that the system components are properly configured for use with the rear I/O module.

3. If appropriate, ensure that the onboard peripheral devices are properly installed prior to installation.
4. Ensure that no power is applied to the system before proceeding.



### **Warning!**

Even though power may be removed from the system, the rear I/O module's front panel cables may have power applied which comes from an external source.

In addition, these cables may be connected to devices that can be damaged by electrostatic discharging or short-circuiting of pins.

It is the responsibility of the system designer or integrator to ensure that appropriate measures are taken to preclude damage to the system or injury to personnel which may arise from the handling of these cables (connecting or disconnecting).

Kontron disclaims all liability for damages or injuries resulting from failure to comply with the above.



### **Warning!**

When performing the next step, **DO NOT** push the rear I/O module into the backplane connectors. Use the ejector handles to seat the rear I/O module into the backplane connectors.

5. Carefully insert the rear I/O module into the slot designated by the application requirements for the rear I/O module until it makes contact with the backplane connectors.
6. Using both ejector handles, engage the rear I/O module with the backplane. When the ejector handles are locked, the rear I/O module is engaged.
7. Fasten the two front panel retaining screws.
8. Connect all external interfacing cables to the rear I/O module as required.
9. Ensure that the rear I/O module and all required interfacing cables are properly secured.

The rear I/O module is now ready for operation.



### 3.3 Rear I/O Module Removal Procedures

To remove the rear I/O module proceed as follows:

1. Ensure that the safety requirements indicated in Chapter 3.1 are observed.



#### **Warning!**

Care must be taken when applying the procedures below to ensure that neither the rear I/O module nor system boards are physically damaged by the application of these procedures.

2. Ensure that no power is applied to the system before proceeding.



#### **Warning!**

Even though power may be removed from the system, the rear I/O module's front panel cables may have power applied which comes from an external source.

In addition, these cables may be connected to devices that can be damaged by electrostatic discharging or short-circuiting of pins.

It is the responsibility of the system designer or integrator to ensure that appropriate measures are taken to preclude damage to the system or injury to personnel which may arise from the handling of these cables (connecting or disconnecting).

Kontron disclaims all liability for damages or injuries resulting from failure to comply with the above.

3. Disconnect any interfacing cables that may be connected to the rear I/O module.
4. Unscrew the two front panel retaining screws.
5. Disengage the rear I/O module from the backplane by first unlocking the ejection handles and then by pressing the handles as required until the rear I/O module is disengaged.
6. After disengaging the rear I/O module from the backplane, pull it out of the slot.
7. Dispose of the rear I/O module as required.

### 3.4 Installation of Peripheral Devices

The CP-RIO6-001-HD-VGA is designed to accommodate a variety of peripheral devices whose installation varies considerably. The following chapters provide information regarding installation aspects and not detailed procedures.

#### 3.4.1 USB Device Installation

The CP-RIO6-001-HD-VGA supports all USB Plug and Play computer peripherals (e.g. keyboard, mouse, printer, etc.).



#### **Note ...**

All USB devices may be connected or removed while the host or other peripherals are powered up.



### 3.4.2 USB 2.0 NAND Flash Module Installation

One USB 2.0 NAND Flash module may be connected to the CP-RIO6-001-HD-VGA via the on-board USB 2.0 NAND Flash connector, J14.

The USB 2.0 NAND Flash module must be physically installed on the CP-RIO6-001-HD-VGA prior to installation of the rear I/O module in a system.

During installation it is necessary to ensure that the USB 2.0 NAND Flash module is properly seated in the onboard USB 2.0 NAND Flash connector, i.e. the pins are correctly aligned and not bent.



#### **Note ...**

Only qualified USB 2.0 NAND Flash modules from Kontron are authorized for use with the CP-RIO6-001-HD-VGA. Use of unqualified USB 2.0 NAND Flash modules or improper installation will void the warranty and may result in damage to the CP-RIO6-001-HD-VGA or the system.

If this module is ordered separately, it is delivered with two screws and a standoff to assemble the module to the CP-RIO6-001-HD-VGA. To do this first install the standoff, then mount the module itself and fixate it with the second screw.

Refer to Figure 3-1 for placement of the USB 2.0 NAND Flash module.

### 3.4.3 Installation of an External Serial ATA Device

One external SATA device may be connected to the CP-RIO6-001-HD-VGA via the onboard SATA connector J13 as well as the appropriate SATA cable.

Some symptoms of incorrectly installed SATA devices are:

- Device on a SATA channel does not spin up: check power cables and cabling. May also result from a bad power supply or SATA device.

The SATA connector on the CP-RIO6-001-HD-VGA provides only a data connection. The power for this device must be supplied by a separate connector. For further information, refer to the respective documentation of the device.

- SATA device fail message at boot-up: may be a bad cable or lack of power going to the drive.



#### **Warning!**

The incorrect connection of power or data cables may damage the SATA device and/or the CP-RIO6-001-HD-VGA.



### 3.4.4 Installation of a 2.5" SATA HDD/SSD Device

One 2.5" SATA HDD/SSD may be installed on the CP-RIO6-001-HD-VGA via the onboard SATA connector J15. During installation it is necessary to ensure that the SATA device is correctly seated in the onboard SATA connector and properly secured via the four mounting screws.

The following figure shows the placement of the 2.5" SATA HDD/SSD and the USB 2.0 NAND Flash on the CP-RIO6-001-HD-VGA.

**Figure 3-1: Placement of the Onboard Mass Storage Devices**

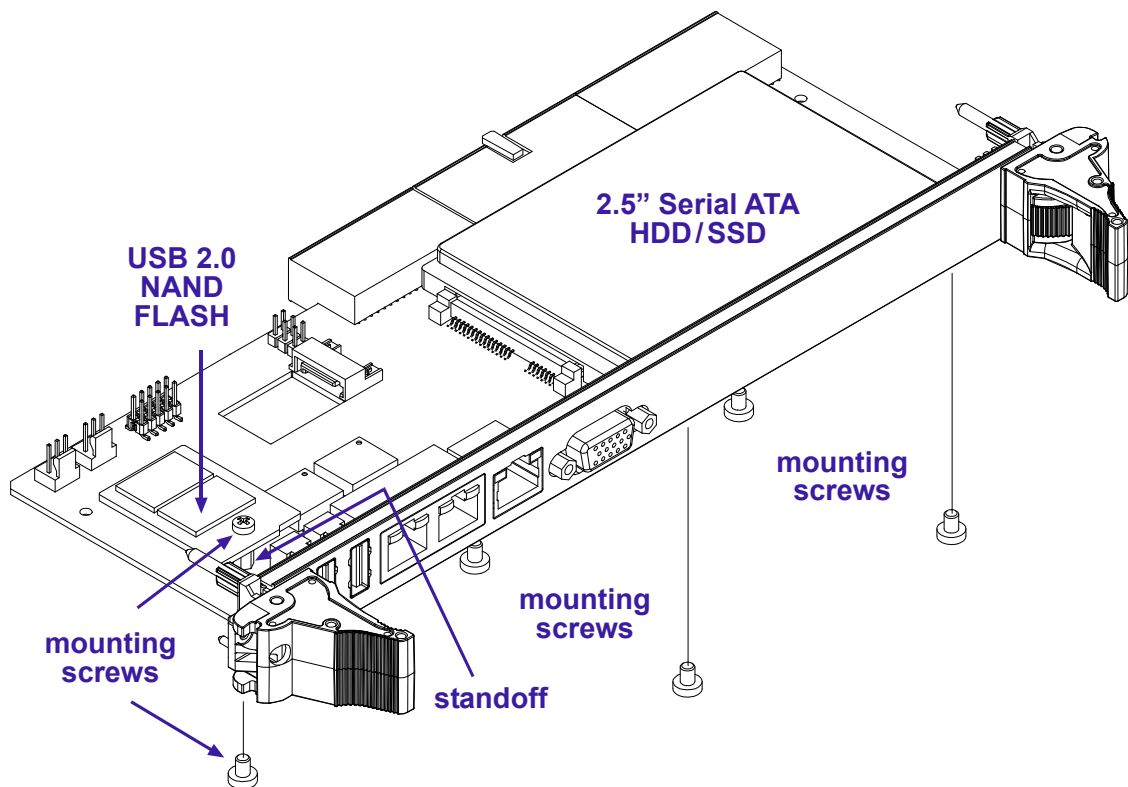

**Note ...**

The CP-RIO6-001-HD-VGA supports SATA devices with a maximum start-up current of 1.1 A (5.5 W) and a maximum operating current of 0.7 A (3.5 W) on the 5 V voltage supply.



This page has been intentionally left blank.

