



KISS 4U V3 ADL

Doc. User Guide, Rev. 1.1

Doc. ID: 1070-5082

This page has been intentionally left blank

 KISS 4U V3 ADL - USER GUIDE

Disclaimer

Kontron would like to point out that the information contained in this user guide may be subject to alteration, particularly as a result of the constant upgrading of Kontron products. This document does not entail any guarantee on the part of Kontron with respect to technical processes described in the user guide or any product characteristics set out in the user guide. Kontron assumes no responsibility or liability for the use of the described product(s), conveys no license or title under any patent, copyright or mask work rights to these products and makes no representations or warranties that these products are free from patent, copyright or mask work right infringement unless otherwise specified. Applications that are described in this user guide are for illustration purposes only. Kontron makes no representation or warranty that such application will be suitable for the specified use without further testing or modification. Kontron expressly informs the user that this user guide only contains a general description of processes and instructions that may not be applicable in every individual case. In cases of doubt, contact Kontron.

This user guide is protected by copyright. All rights are reserved by Kontron. No part of this document may be reproduced, transmitted, transcribed, stored in a retrieval system, or translated into any language or computer language, in any form or by any means (electronic, mechanical, photocopying, recording, or otherwise), without the express written permission of Kontron. Kontron points out that the information contained in this user guide is constantly being updated in line with the technical alterations and improvements made by Kontron to the products and thus this user guide only reflects the technical status of the products by Kontron at the time of publishing.

Brand and product names are trademarks or registered trademarks of their respective owners.

©2023 by Kontron Europe GmbH

Kontron Europe GmbH

Gutenbergstraße. 2

85737 Ismaning

Germany

www.kontron.com

Intended Use

This product, sold by Kontron, is also intended for the use in harsh industrial environments. The product can operate in a temperature range from 0°C to plus 50°C; the storage elements can withstand temperatures from minus 20°C to plus 70°C, and a humidity of 10 to 93 percent does not affect the function of the Product. This makes it particularly suitable for use in industrial automation, process control, high-end image processing and for SCADA/MES applications. This product can be installed in tower, desktop and rackmount environments, as more described in this user guide. You must comply with all product specifications stated in the product documentation and this user manual. If you intend, to incorporated the product into any total systems or applications, please carry out sufficient, compatibility and functions tests prior to any use or resale.

THIS PRODUCT IS NOT DESIGNED, MANUFACTURED OR INTENDED FOR USE OR RESALE FOR THE OPERATION OF APPLICATION IN A HAZARDOUS ENVIRONMENT, OR REQUIRING FAIL-SAFE PERFORMANCE, OR IN WHICH THE FAILURE OF PRODUCTS COULD LEAD DIRECTLY TO DEATH, PERSONAL INJURY, OR SEVERE PHYSICAL OR ENVIRONMENTAL DAMAGE (COLLECTIVELY "HIGH RISK APPLICATIONS").

You understand and agree that your use of Kontron products as a component in High Risk Applications is entirely at your own risk. To minimize the risks associated with your systems and applications, you must provide adequate design and operating safeguards. You are responsible to ensure that your systems (and any Kontron hardware or software products incorporated in your systems) meet all applicable requirements. Unless otherwise stated in the product documentation, the Kontron product is not provided with error-tolerance capabilities and therefore cannot be deemed as being engineered, manufactured or setup to be compliant for implementation or for resale as a component in High Risk Applications. All application and safety related information in this document (including application descriptions, suggested safety measures, suggested Kontron products, and other materials) is provided for reference only.

NOTICE

You find the most recent version of the "General Safety Instructions" online in the download area of this product.

NOTICE

This product is not suited for storage or operation in corrosive environments, in particular under exposure to sulfur and chlorine and their compounds. For information on how to harden electronics and mechanics against these stress conditions, contact Kontron Support.

Revision History

Revision	Brief Description of Changes	Date of Issue	Author/Editor
1.0	Initial version	2023-Aug-11	CW
1.1	Replace Linux Ubuntu with Linux	2023-Sept-15	CW

Terms and Conditions

Kontron warrants products in accordance with defined regional warranty periods. For more information about warranty compliance and conformity, and the warranty period in your region, visit <https://www.kontron.com/terms-and-conditions>.

Kontron sells products worldwide and declares regional General Terms & Conditions of Sale, and Purchase Order Terms & Conditions. Visit <https://www.kontron.com/terms-and-conditions>.

For contact information, refer to the corporate offices contact information on the last page of this user guide or visit our website [CONTACT US](#).

Customer Support

Find Kontron contacts by visiting: <https://www.kontron.com/support-and-services>.

Customer Service

As a trusted technology innovator and global solutions provider, Kontron extends its embedded market strengths into a services portfolio allowing companies to break the barriers of traditional product lifecycles. Proven product expertise coupled with collaborative and highly-experienced support enables Kontron to provide exceptional peace of mind to build and maintain successful products.

For more details on Kontron's service offerings such as: enhanced repair services, extended warranty, Kontron training academy, and more visit <https://www.kontron.com/support-and-services>.

Customer Comments

If you have any difficulties using this user guide, discover an error, or just want to provide some feedback, contact [Kontron Support](#). Detail any errors you find. We will correct the errors or problems as soon as possible and post the revised user guide on our website.

Symbols

The following symbols may be used in this user guide

DANGER

DANGER indicates a hazardous situation which, if not avoided, will result in death or serious injury.

WARNING

WARNING indicates a hazardous situation which, if not avoided, could result in death or serious injury.

NOTICE

NOTICE indicates a property damage message.

CAUTION

CAUTION indicates a hazardous situation which, if not avoided, may result in minor or moderate injury.



Electric Shock!

This symbol and title warn of hazards due to electrical shocks (> 60 V) when touching products or parts of products. Failure to observe the precautions indicated and/or prescribed by the law may endanger your life/health and/or result in damage to your material.



ESD Sensitive Device!

This symbol and title inform that the electronic boards and their components are sensitive to static electricity. Care must therefore be taken during all handling operations and inspections of this product in order to ensure product integrity at all times.



HOT Surface!

Do NOT touch! Allow to cool before servicing.



Laser!

This symbol inform of the risk of exposure to laser beam and light emitting devices (LEDs) from an electrical device. Eye protection per manufacturer notice shall review before servicing.



This symbol indicates general information about the product and the user guide.

This symbol also indicates detail information about the specific product configuration.



This symbol precedes helpful hints and tips for daily use.

For Your Safety

Your new Kontron product was developed and tested carefully to provide all features necessary to ensure its compliance with electrical safety requirements. It was also designed for a long fault-free life. However, the life expectancy of your product can be drastically reduced by improper treatment during unpacking and installation. Therefore, in the interest of your own safety and of the correct operation of your new Kontron product, you are requested to conform with the following guidelines.

High Voltage Safety Instructions

As a precaution and in case of danger, the power connector must be easily accessible. The power connector is the product's main disconnect device.

⚠ CAUTION

Warning

All operations on this product must be carried out by sufficiently skilled personnel only.

⚠ CAUTION



Electric Shock!

Before installing a non-hot-swappable Kontron product into a system always ensure that your mains power is switched off. This also applies to the installation of piggybacks. Serious electrical shock hazards can exist during all installation, repair, and maintenance operations on this product. Therefore, always unplug the power cable and any other cables which provide external voltages before performing any work on this product.

Earth ground connection to vehicle's chassis or a central grounding point shall remain connected. The earth ground cable shall be the last cable to be disconnected or the first cable to be connected when performing installation or removal procedures on this product.

Special Handling and Unpacking Instruction

NOTICE



ESD Sensitive Device!

Electronic products and their components are sensitive to static electricity. Therefore, care must be taken during all handling operations and inspections of this product, in order to ensure product integrity at all times.

⚠ CAUTION

Handling and operation of the product is permitted only for trained personnel within a work place that is access controlled. Follow the "General Safety Instructions for IT Equipment" supplied with the product.

Do not handle this product out of its protective enclosure while it is not used for operational purposes unless it is otherwise protected.

Whenever possible, unpack or pack this product only at EOS/ESD safe work stations. Where a safe work station is not guaranteed, it is important for the user to be electrically discharged before touching the product with his/her hands or tools. This is most easily done by touching a metal part of your system housing.

It is particularly important to observe standard anti-static precautions when changing piggybacks, ROM devices, jumper settings etc. If the product contains batteries for RTC or memory backup, ensure that the product is not placed on conductive surfaces, including anti-static plastics or sponges. They can cause short circuits and damage the batteries or conductive circuits on the product.

Lithium Battery Precautions

If your product is equipped with a lithium battery, take the following precautions when replacing the battery.

⚠ CAUTION

CAUTION: Risk of Explosion if the lithium battery is replaced by an incorrect type. Dispose of used lithium batteries according to the Instructions.

ATTENTION: Risque d'explosion si la pile au lithium est remplacée par une pile de type incorrect. Éliminez les piles au lithium usagées conformément aux instructions.

General Instructions on Usage

In order to maintain Kontron's product warranty, this product must not be altered or modified in any way. Changes or modifications to the product, that are not explicitly approved by Kontron and described in this user guide or received from Kontron Support as a special handling instruction, will void your warranty.

This product should only be installed in or connected to systems that fulfill all necessary technical and specific environmental requirements. This also applies to the operational temperature range of the specific product version that must not be exceeded.

In performing all necessary installation and application operations, only follow the instructions supplied with this user guide.

Keep all the original packaging material for future storage or warranty shipments. If it is necessary to store or ship the product then re-pack the product in the same manner as the product was delivered.

Special care is necessary when handling or unpacking the product. Refer to any special handling and unpacking instructions within this user guide.

Quality and Environmental Management

Kontron aims to deliver reliable high-end products designed and built for quality, and aims to complying with environmental laws, regulations, and other environmentally oriented requirements. For more information regarding Kontron's quality and environmental responsibilities, visit <http://www.kontron.com/about-kontron/corporate-responsibility/quality-management>.

Disposal and Recycling

Kontron's products are manufactured to satisfy environmental protection requirements where possible. Many of the components used are capable of being recycled. Final disposal of this product after its service life must be accomplished in accordance with applicable country, state, or local laws or regulations.

WEEE Compliance

The Waste Electrical and Electronic Equipment (WEEE) Directive aims to:

- ▶ Reduce waste arising from electrical and electronic equipment (EEE)
- ▶ Make producers of EEE responsible for the environmental impact of their products, especially when the product become waste
- ▶ Encourage separate collection and subsequent treatment, reuse, recovery, recycling and sound environmental disposal of EEE
- ▶ Improve the environmental performance of all those involved during the lifecycle of EEE



Environmental protection is a high priority with Kontron.
Kontron follows the WEEE directive

Table of Contents

Symbols	6
For Your Safety	7
High Voltage Safety Instructions	7
Special Handling and Unpacking Instruction	7
Lithium Battery Precautions.....	8
General Instructions on Usage	8
Quality and Environmental Management	8
Disposal and Recycling.....	8
WEEE Compliance.....	8
Table of Contents	9
List of Tables	11
List of Figures	12
1/ Introduction	13
2/ General Safety Instructions	15
2.1. Instructions générales de sécurité.....	16
2.2. Electrostatic Discharge (ESD)	17
2.3. Grounding Methods	17
2.4. Instructions for the Lithium Battery	18
2.5. Operation of Laser Source Devices.....	19
3/ Shipment and Unpacking	20
3.1. Packaging.....	20
3.2. Unpacking.....	20
3.3. Scope of Delivery.....	20
3.4. Accessories and Spare Parts.....	20
3.5. Product Identification Type Label	21
4/ Product Features	22
4.1. Front Side.....	23
4.1.1. Front Flap.....	24
4.1.2. Drive Bays	25
4.1.3. Handle Brackets	25
4.1.4. Fan Assembly	26
4.1.5. Filter Pad and Filter Pad Holder	27
4.1.6. Power Button	27
4.1.7. Power LED and HDD LED	28
4.1.8. USB Ports	28
4.2. Rear Panel.....	29
4.2.1. Display Port (DP).....	30
4.2.2. USB 3.2.....	30
4.2.3. LAN.....	30
4.2.4. Audio	31
4.2.5. Serial Ports (COM)	31
4.2.6. Power Supply Units.....	32
4.2.7. Potential Equalization Stud	33
4.2.8. PCIE/PCI Expansion Card Slots.....	34
4.3. Side.....	35
4.4. Cover	36
4.5. System Configuration	37

5/	System Expansion	38
5.1.	Before Expanding	38
5.2.	Mass Storage (Internal)	38
5.3.	Drive Bays	38
5.4.	Expansion Cards	39
5.4.1.	Reference PCIe Expansion Card	39
6/	Thermal Management	41
6.1.	Active Cooling	41
6.2.	Temperature Sensor	41
6.3.	Minimum System Clearance	41
6.4.	Third Party Components	42
7/	Assembly	43
7.1.	Before Assembling the Product	43
7.2.	Opening and Closing the Cover	43
7.3.	Installing and Removing PCIe/PCI Expansion Cards	45
7.4.	Installing and Removing the Handle Brackets	47
7.5.	Installing and Removing the Front Flap	48
7.6.	Installing the Rubber Feet (option)	48
7.7.	Installing Slide Rails (option)	49
8/	Installation	51
8.1.	Before Installing	51
8.2.	Installing as a Desktop	52
8.3.	Installing in a 19" Industrial Rack Cabinet	52
9/	Starting Up	54
9.1.	Before Starting	54
9.2.	Connecting the Power Supply	54
9.3.	Connecting to the Redundant Power Supply (option)	55
9.4.	Switching On	56
9.5.	Operating System and Hardware Component Drivers	56
10/	BIOS	57
10.1.	Starting the BIOS	57
10.2.	BIOS Setup Menus	57
10.3.	BIOS Navigation	58
10.4.	BIOS Update	58
10.5.	Updating the BIOS	58
10.6.	Recover BIOS	59
11/	Product Specifications	60
11.1.	Block Diagrams	60
11.2.	Hardware Specification	61
11.3.	Software Specification	62
11.4.	Power Specification	62
11.5.	Environmental Specification	63
11.6.	Mechanical Specification	64
11.7.	Compliance	64
12/	Standard Interfaces- Pin Assignments	66
12.1.	DP Port Pin Assignment	66
12.2.	USB 3.2 Gen 2/1 Pin Assignment	66
12.3.	USB-C 3.2 Gen 2 Port Pin Assignment	67
12.4.	2.5 GbE/1.0 GbE Pin Assignment	67

12.5. COM Port Pin Assignment	68
12.6. Audio Jack Connector Pin Assignment (Line-in, Line-out, Mic-in)	68
12.7. M.2 Key M (NVME SSD) Socket Pin Assignment	69
12.8. Jumpers.....	70
12.8.1. Recover BIOS Jumper	70
13/ Maintenance and Prevention.....	71
13.1. Before Maintaining the Product	71
13.2. Cleaning the Product	71
13.3. Cleaning the Filter Pad.....	71
13.4. Replacing the Fan Assembly.....	73
13.5. Replacing the Faulty Redundant PSU.....	75
13.6. Replacing the Lithium Battery	76
13.7. Replacing a M.2 SSD Module.....	76
14/ Storage and Transportation	78
14.1. Storage.....	78
14.2. Transportation	78
15/ Technical Support.....	79
15.1. Returning Defective Merchandise	79
16/ Warranty.....	81
16.1. Limitation/Exemption from Warranty Obligation.....	81
Appendix: List of Acronyms	82
About Kontron	83

List of Tables

Table 1: Scope of Delivery.....	20
Table 2: Accessories and Spares Parts	20
Table 3: Power LED and HDD LED Activity.....	28
Table 4: Display Resolution	30
Table 5: Display Order Priority	30
Table 6: Redundant PSU LED Description.....	33
Table 7: Mass Storage Devices	38
Table 8: Drive Bays	38
Table 9: PCIe/PCI Expansion Card Slot Allocation	39
Table 10: Reference KISS 4U V3 ADL PCIe Expansion Cards.....	39
Table 11: Navigation Hot Keys in the Legend Bar	58
Table 12: Hardware Specification.....	61
Table 13: Software Specification	62
Table 14: Electrical Specification.....	62
Table 15: Environmental Specification	63
Table 16: Mechanical Specification.....	64
Table 17: CE Compliance.....	64
Table 18: International Compliance.....	65
Table 19: DP V1.4a Pin Assignment.....	66
Table 20: USB 3.2 Gen 1 Pin Assignment.....	66
Table 22: USB 3.2 Gen 2 Type C Pin Assignment.....	67
Table 23: LAN (RJ45) Connector Pin Assignment.....	67
Table 24: RS232 Connector Pin Assignment	68
Table 25: Audio Jack Pin Assignment	68
Table 26: M.2 Key M Socket Pin Assignment.....	69
Table 27: Recover BIOS Jumper.....	70
Table 28: List of Acronyms.....	82

List of Figures

Figure 1: KISS 4U V3 ADL.....	13
Figure 2: Type Label Example.....	21
Figure 3: Rackmount Variant (closed front flap).....	22
Figure 4: Desktop Variant (closed front flap).....	22
Figure 5: Rackmount Variant (opened front flap).....	22
Figure 6: Desktop Variant (opened front flap).....	22
Figure 7: Front Side (front flap closed).....	23
Figure 8: Front Panel (front flap open).....	24
Figure 9: Drive Bays.....	25
Figure 10: Handle Bracket.....	25
Figure 11: Fan Assembly.....	26
Figure 12: Power Button.....	27
Figure 13: LED Indicators.....	28
Figure 14: USB 3.2 Gen 1 Port.....	28
Figure 15: Rear Panel.....	29
Figure 16: Single PSU (600 W).....	32
Figure 17: Redundant 500 W PSU.....	33
Figure 18: Left Side.....	35
Figure 19: Right Side.....	35
Figure 20: Cover Underside.....	36
Figure 21: Example of KISS 4U V3 ADL Configuration.....	37
Figure 22: Loosening Knurled Screw (front panel).....	43
Figure 23: Loosening Knurled Screws (rear panel).....	44
Figure 24: Pull and Release the Cover.....	44
Figure 25: Removing the Cover.....	44
Figure 26: Short and Long Brackets, and PCB Holder.....	45
Figure 27: Steps to Remove/Install the Short and Long Brackets.....	46
Figure 28: Removing the Handle Brackets.....	47
Figure 29: Front Flap Side-plate (left and right).....	48
Figure 30: Slide Rail Inner Part.....	49
Figure 31: Slide Rail in Pulled-out Position.....	49
Figure 32: Slide Rail in Pushed-in Position.....	50
Figure 33: Assembling the Slide Rails in an Industrial Rack Cabinet.....	50
Figure 34: Input Power Socket.....	54
Figure 35: Redundant Power Supply.....	55
Figure 36: Power Button.....	56
Figure 37: BIOS FTP Server.....	58
Figure 38: Block Diagram KISS 4U V3 ADL.....	60
Figure 39: Recover BIOS Jumper.....	70
Figure 40: Front Side with Filter Pad Holder.....	72
Figure 41: Fan Assemble without Filter Pad Holder.....	73
Figure 42: Filter Pad Holder (without filter pad).....	73
Figure 43: Filter Pad Holder (with filter pad).....	73
Figure 44: Filter Pad.....	73
Figure 45: Removing the Fan Assembly.....	74
Figure 46: Fan Compartment (without fan assembly).....	74

1/ Introduction

This user guide focuses on describing the special features of the KISS 4U V3 ADL scalable 4U rackmount system also known as product within this user guide. This user guide includes detailed information and guidelines for set up, assembly, mounting and maintenance. New users are recommended to study the instructions and any warning notices within this user guide before handling or switching on the product.

The KISS 4U V3 ADL is a scalable 4U industrial rackmount system designed for high performance, reliability in a 19" industrial rack cabinet, or flexibly installed in harsh industrial environments. Based on Kontron's industrial series of ATX motherboards, with the Intel® 12th/13th Gen Core™ processor series, the product supports multiple expansion capabilities and external interfaces.

Figure 1: KISS 4U V3 ADL



General features are:

- ▶ ATX motherboard
- ▶ Intel® 12th and 13th Gen Core-i™ i9, i7, i5 und i3 processor series
- ▶ Intel® R680E chipset
- ▶ Up to 128 GB system memory with four DIMM sockets DDR5-4800 MHz
- ▶ 2x M.2 2280 PCIe drive (internal)
- ▶ Mass Storage capabilities with M.2, HDD, SSD and DVD devices
- ▶ Drive bays
 - ▶ 3x 5.25 Drive bays
 - ▶ 1x DVD R/W slim (option) or Internal 3.5" drive (option)
 - ▶ RAID support
- ▶ Expansion slots:
 - ▶ PCIe x16: Gen 5 (16 Lanes)
 - ▶ PCIe x 1 Gen 3 (open slot)
 - ▶ PCIe x16 Gen 4 (4 Lanes)
 - ▶ PCIe x8 Gen 3 (4 lanes)
 - ▶ PCIe x8 Gen4 (4 lanes) (open slot)
 - ▶ PCIe x1 Gen3 (open slot)
 - ▶ PCI 1x32 Bit
- ▶ External Interfaces front
 - ▶ 2x USB 3.2 Gen 1

- ▶ External Interfaces rear
 - ▶ 4x USB 3.2 Gen 1 (Type A), 2x USB 3.2 Gen 2 (Type A), 1x USB-C 3.2 Gen 2 (Type C)
 - ▶ 4x DP V1.4a @4K
 - ▶ 1x 1 GbE
 - ▶ 2x 2.5 GbE
 - ▶ 1x RS232 serial port
 - ▶ 1x audio (Line-in, Line-out, Mic)
- ▶ Active cooling
- ▶ Power Supply
 - ▶ Single 600 W PSU
 - ▶ Redundant 500 W PSU (option)
 - ▶ Redundant 750 W PSU (on-request)



To ensure you have the latest version of this user guide, visit Kontron's industrial computer website: [Kontron Rack Mount Systems 4U](#).

2/ General Safety Instructions

Please read this passage carefully and take careful note of the instructions, which have been compiled for your safety and to ensure to apply in accordance with intended regulations. If the following general safety instructions are not observed, it could lead to injuries to the operator and/or damage of the product; in cases of non-observance of the instructions Kontron Europe is exempt from accident liability, this also applies during the warranty period.

The product has been built and tested according to the basic safety requirements for low voltage (LVD) applications and has left the manufacturer in safety-related, flawless condition. To maintain this condition and to also ensure safe operation, the operator must not only observe the correct operating conditions for the product but also the following general safety instructions:

- ▶ The product must be used as specified in the product documentation, in which the instructions for safety for the product and for the operator are described. These contain guidelines for setting up, installation and assembly, maintenance, transport or storage.
- ▶ The on-site electrical installation must meet the requirements of the country's specific local regulations.
- ▶ If a power cable comes with the product, only this cable should be used. Do not use an extension cable to connect the product.
- ▶ To guarantee that sufficient air circulation is available to cool the product, please ensure that the ventilation openings are not covered or blocked. If a filter mat is provided, this should be cleaned regularly. Do not place the product close to heat sources or damp places. Make sure the product is well ventilated.
- ▶ Only connect the product to an external power supply providing the voltage type (AC or DC) and the input power (max. current) specified on the Kontron Product Label and meeting the requirements of the Limited Power Source (LPS) and Power Source (PS2) of UL/IEC 62368-1.
- ▶ Only products or parts that meet the requirements for Power Source (PS1) of UL/IEC 62368-1 may be connected to the product's available interfaces (I/O).
- ▶ Before opening the product, make sure that the product is disconnected from the mains.
- ▶ Switching off the product by its power button does not disconnect it from the mains. Complete disconnection is only possible if the power cable is removed from the wall plug or from the product. Ensure that there is free and easy access to enable disconnection.
- ▶ The product may only be opened for the insertion or removal of add-on cards (depending on the configuration of the product). This may only be carried out by qualified operators.
- ▶ If extensions are being carried out, the following must be observed:
 - ▶ all effective legal regulations and all technical data are adhered to
 - ▶ the power consumption of any add-on card does not exceed the specified limitations
 - ▶ the current consumption of the product does not exceed the value stated on the product label.
- ▶ Only original accessories that have been approved by Kontron Europe can be used.
- ▶ Please note: safe operation is no longer possible when any of the following applies:
 - ▶ the product has visible damages or
 - ▶ the product is no longer functioning
 In this case the product must be switched off and it must be ensured that the product can no longer be operated.
- ▶ Handling and operation of the product is permitted only for trained personnel within a work place that is access controlled.
- ▶ CAUTION: Risk of explosion if the battery is replaced incorrectly (short-circuited, reverse-poled, wrong battery type). Dispose of used batteries according to the manufacturer's instructions.
- ▶ This product is not suitable for use in locations where children are likely to be present

Additional Safety Instructions for DC Power Supply Circuits

- ▶ To guarantee safe operation, please observe that:
 - ▶ the external DC power supply must meet the criteria for LPS and PS2 (UL/IEC 62368-1)

- ▶ no cables or parts without insulation in electrical circuits with dangerous voltage or power should be touched directly or indirectly
- ▶ a reliable protective earthing connection is provided
- ▶ a suitable, easily accessible disconnecting device is used in the application (e.g. overcurrent protective device), if the product itself is not disconnectable
- ▶ a disconnect device, if provided in or as part of the product, shall disconnect both poles simultaneously
- ▶ interconnecting power circuits of different products cause no electrical hazards
- ▶ A sufficient dimensioning of the power cable wires must be selected – according to the maximum electrical specifications on the product label – as stipulated by EN62368-1 or VDE0100 or EN60204 or UL61010-1 regulations.

2.1. Instructions générales de sécurité

Veillez lire attentivement ce passage et prendre bonne note des instructions, qui ont été compilées pour votre sécurité et pour assurer une application conforme aux réglementations prévues. Le non-respect des consignes de sécurité générales suivantes peut entraîner des blessures pour l'utilisateur et/ou des dommages pour le produit. En cas de non-respect des consignes, Kontron Europe est exonéré de la responsabilité en cas d'accident, ceci s'applique également pendant la période de garantie.

Le produit a été construit et testé conformément aux exigences de sécurité de base pour les applications basse tension (DBT) et a quitté le fabricant dans un état impeccable en matière de sécurité. Pour maintenir cet état et pour garantir également un fonctionnement sûr, l'opérateur doit non seulement respecter les conditions d'utilisation correctes du produit, mais aussi les consignes de sécurité générales suivantes :

- ▶ Le produit doit être utilisé conformément à la documentation du produit, dans laquelle sont décrites les instructions de sécurité pour le produit et pour l'opérateur. Celles-ci contiennent des directives pour la mise en place, l'installation et le montage, la maintenance, le transport ou le stockage.
- ▶ L'installation électrique sur place doit répondre aux exigences des réglementations locales spécifiques du pays.
- ▶ Si un câble d'alimentation est fourni avec le produit, seul ce câble doit être utilisé. N'utilisez pas de rallonge pour connecter le produit.
- ▶ Afin de garantir une circulation d'air suffisante pour refroidir le produit, veuillez vous assurer que les ouvertures de ventilation ne sont pas couvertes ou obstruées. Si un élément filtrant est fourni, celui-ci doit être nettoyé régulièrement. Ne placez pas le produit à proximité de sources de chaleur ou d'endroits humides. Veillez à ce que le produit soit bien ventilé.
- ▶ Ne connectez le produit qu'à une alimentation externe fournissant le type de tension (AC ou DC) et la puissance d'entrée (courant max.) spécifiés sur le Label Produit Kontron et répondant aux exigences de la source d'alimentation limitée (LPS) et de la source d'alimentation (PS2) de la norme UL/IEC 62368-1.
- ▶ Seuls les produits ou les pièces qui répondent aux exigences de la source d'alimentation (PS1) de la norme UL/IEC 62368-1 peuvent être connectés aux interfaces (E/S) disponibles du produit.
- ▶ Avant d'ouvrir le produit, assurez-vous qu'il est bien débranché du secteur.
- ▶ Le fait d'éteindre le produit par son bouton de mise en marche ne le déconnecte pas du secteur. Une déconnexion complète n'est possible que si le câble d'alimentation est retiré de la prise murale ou du produit. Veillez à ce que l'accès soit libre et facile pour permettre la déconnexion.
- ▶ Le produit ne peut être ouvert que pour l'insertion ou le retrait de cartes supplémentaires (selon la configuration du produit). Cette opération ne peut être effectuée que par des opérateurs qualifiés.
- ▶ Si des extensions sont effectuées, les points suivants doivent être respectés :
 - ▶ toutes les réglementations légales en vigueur et toutes les données techniques sont respectées
 - ▶ la consommation électrique d'une carte supplémentaire ne dépasse pas les limites spécifiées
 - ▶ la consommation actuelle du produit ne dépasse pas la valeur indiquée sur l'étiquette du produit.
- ▶ Seuls les accessoires d'origine approuvés par Kontron Europe peuvent être utilisés.
- ▶ Veillez noter que la sécurité des opérations n'est plus possible lorsque l'une des conditions suivantes s'applique.

- ▶ le produit présente des dommages visibles ou
 - ▶ le produit ne fonctionne plus. Dans ce cas, le produit doit être éteint et il faut s'assurer que le produit ne puisse plus être utilisé.
 - ▶ La manipulation et le fonctionnement du produit ne sont autorisés que pour le personnel formé dans un lieu de travail dont l'accès est contrôlé.
 - ▶ ATTENTION: Risque d'explosion si la batterie est remplacée de manière incorrecte (court-circuit, inversion de polarité, mauvais type de batterie). Éliminez les piles usagées conformément aux instructions du fabricant.
 - ▶ Ce produit n'est pas adapté à une utilisation dans des endroits où des enfants sont susceptibles d'être présents
- Instructions de sécurité supplémentaires pour les circuits d'alimentation en courant continu
- ▶ Pour garantir un fonctionnement sûr, veuillez observer ce qui suit:
 - ▶ l'alimentation électrique externe en courant continu doit répondre aux critères des LPS et PS2 (UL/IEC 62368-1)
 - ▶ aucun câble ou pièce non isolée dans les circuits électriques ayant une tension ou une puissance dangereuse ne doit être touché directement ou indirectement
 - ▶ une connexion fiable à la terre de protection est fournie
 - ▶ un dispositif de déconnexion approprié et facilement accessible est utilisé dans l'application (par exemple, un dispositif de protection contre les surintensités), si le produit lui-même n'est pas en mesure d'être déconnecté.
 - ▶ un dispositif de déconnexion, s'il est prévu dans le produit ou s'il en fait partie, doit déconnecter les deux pôles simultanément
 - ▶ l'interconnexion des circuits électriques de différents produits ne présente aucun risque électrique
 - ▶ Un dimensionnement suffisant des fils du câble d'alimentation doit être choisi - en fonction des spécifications électriques maximales figurant sur l'étiquette du produit - comme stipulé par les réglementations EN62368-1 ou VDE0100 ou EN60204 ou UL61010-1.

2.2. Electrostatic Discharge (ESD)



A sudden discharge of electrostatic electricity can destroy static-sensitive devices.

Proper packaging and grounding techniques are necessary precautions to prevent damage. Always take the following precautions:

1. Transport ESD-sensitive products in ESD-safe containers such as boxes or bags.
2. Always be properly grounded when touching sensitive products, components, or assembly.
3. Store ESD-sensitive products in protective packaging or on antistatic mats.

2.3. Grounding Methods

To avoid electrostatic damage, observe the following grounding guidelines:

1. Cover workstations with approved antistatic material/mat. Always wear a wrist strap connected to workplace or heel straps.
2. Use properly grounded tools and equipment such as field service tools that are conductive.
3. Always handle ESD sensitive components by their edge or by their casing.
4. Avoid contact with pins, leads, or circuitry.

5. Switch off power and input signals before inserting and removing connectors or connecting test equipment.
6. Keep work area free of non-conductive materials such as ordinary plastic assembly aids and Styrofoam.

2.4. Instructions for the Lithium Battery

When replacing the motherboard's battery, observe the instructions described in Chapter 13.4: Replacing the Lithium Battery.

⚠ CAUTION

Danger of Explosion if the lithium battery is incorrectly placed!

- ▶ Replace only with the same or equivalent type recommended by the manufacturer
- ▶ Dispose of used batteries according to the manufacture's instructions

VORSICHT- Explosionsgefahr bei unsachgemäßem Austausch der Batterie!

- ▶ Ersatz nur durch denselben oder einen vom Hersteller empfohlenen gleichwertigen Typ
- ▶ Entsorgung gebrauchter Batterien nach Angaben des Herstellers

ATTENTION- Risque d'explosion avec l'échange inadéquat de la batterie!

- ▶ Remplacement seulement par le même ou un type équivalent recommandé par le producteur
- ▶ L'évacuation des batteries usagées conformément à des indications du fabricant

PRECAUCION- Peligro de explosi3n si la bater3a se sustituye incorrectamente!

- ▶ Sustituya solamente por el mismo o tipo equivalente recomendado por el fabricante
- ▶ Disponga las bater3as usadas seg3n las instrucciones del fabricante

ADVARSEL- Lithiumbatteri -- Eksplosionsfare ved fejlagtig h3ndtering!

- ▶ Udskiftning m3 kun ske med batteri af samme fabrikat og type
- ▶ Lev3r det brugte batteri tilbage til leverand3ren

ADVARSEL- Eksplosjonsfare ved feilaktig skifte av batteri!

- ▶ Benytt samme batteritype eller en tilsvarende type anbefalt av apparatfabrikanten
- ▶ Brukte batterier kasseres i henhold til fabrikantens instruksjoner

VARNING- Explosionsfara vid felaktigt batteribytle!

- ▶ nv3nd samma batterityp eller en ekvivalent typ som rekommenderas av apparattillverkaren
- ▶ assera anv3nt batteri enligt fabrikantens instruktion

VAROITUS- Paristo voi r3j3ht33, jos se on virheellisesti asennettu!

- ▶ Vaihda paristo ainoastaan l3lteleval- mistajan suosittelemaan tyyppiln
 - ▶ H3vit3 k3ytetty paristo valmistajan ohjeiden mukaisesti
-



Do not dispose of lithium batteries in general trash collection. Dispose of the battery according to the local regulations dealing with the disposal of these special materials, (e.g. to the collecting points for dispose of batteries).

2.5. Operation of Laser Source Devices

The optional DVD drive contain light-emitting diodes (LEDs) (classified in accordance with IEC 60825-1:2007: LASER CLASS 1) and therefore must not be opened. If the enclosure of such a drive is opened, invisible laser radiation is emitted. Do not allow yourself to be exposed to this radiation.

The laser system meets the Code of Federal Regulations (CFR), Title 21, 1040 -Performance standards for light-emitting products.



Laser!

Risk of exposure to laser beam and light emitting devices (LEDs) from DVD

- Do not open DVD drive due to invisible laser radiation
 - Check manufacture instructions eye protection maybe required
-

3/ Shipment and Unpacking

3.1. Packaging

All parts are delivered together in a product specific cardboard package designed to provide adequate protection to absorb shock. Kontron recommends keeping the packaging to store or transport the KISS 4U V3 ADL.

3.2. Unpacking

To unpack the product, perform the following:

1. Remove packaging.
2. Do not discard the original packaging. Keep the original packaging for future transportation or storage.
3. Check the delivery for completeness by comparing the delivery with the original order.
4. Keep the associated paperwork. It contains important information for handling the product.
5. Check the product for visible shipping damage.

If you notice any shipping damage or inconsistencies between the contents and the original order, contact your dealer.

3.3. Scope of Delivery

Check that your delivery is complete, and contains the items listed in Table 1: Scope of delivery. If damaged or missing items are discovered, contact your dealer.

Table 1: Scope of Delivery

Part	Qty.	Part Description
KISS 4U V3-ADL	1	System configuration as ordered
Access key	2	Key for the front flap lock
Rubber feet	4	Self-adhesive feet for the bottom side when used as a desk top
AC power cable	1	With Europe rating, other cable ratings are optional
Safety instructions	1	General Safety Instructions

3.4. Accessories and Spare Parts

Table 2: Accessories and Spares Parts

Part Number	Part Description
1016-5807	Slide rails
1051-7200	Mounting kit slide rail
1035-6957	Filter pad
1035-6968	Fan assembly

3.5. Product Identification Type Label

The type label includes the electrical specification data for the ordered variant

Figure 2: Type Label Example

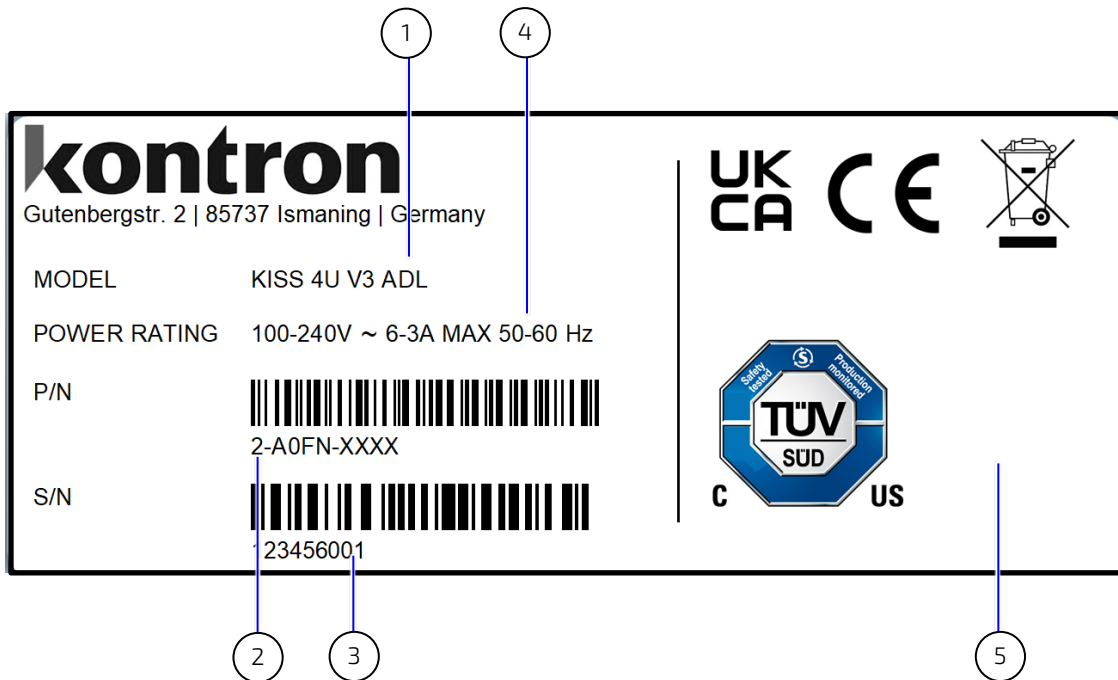

- | | | | |
|---|------------------------------|---|-----------------------------|
| 1 | Model name | 3 | S/N: Specific serial number |
| 2 | P/N: Specific product number | 4 | Power rating |
| | | 5 | Compliance |

4/ Product Features

The KISS 4U V3 ADL expands the Kontron KISS computer line of scalable 4U rackmount systems. The product's design enables installation in 19" industrial racks or as a desktop. The robust construction with excellent mechanical stability offers the superior qualities of a computer designed for operation in harsh industrial environment.

Figure 3: Rackmount Variant (closed front flap)



Figure 4: Desktop Variant (closed front flap)



Figure 5: Rackmount Variant (opened front flap)



Figure 6: Desktop Variant (opened front flap)



The product is designed for horizontal operation. Vertical operation is possible.

The flexible hardware system configuration allows for the implementation of different expansion cards for additional functionality.

Up to four drive bays are available, where drive bays D1, D2 and D3 are front accessible and drive bay D4 is either front accessible or an internal drive.

The power button and the LED indicators are located on the front side and consist of a power LED and a Hard Disk Drive (HDD) activity LED.

Two system fans within a slide-in fan assembly simplify the installation and removal of the system fans, and enables replacement of the fans even during operation. A washable filter pad attaches to the fan assembly to protect against dust and dirt entering the product. The filter pad is replaceable during operation.

The default Power Supply Unit (PSU) is a single 600 W PSU with the option for a redundant 500 W PSU for applications requiring a high level of availability.

4.1. Front Side

The front side consists of two handle brackets for installation in a 19" Industrial rack and a front flap with two front flap side-plates attached using the handle brackets.

Figure 7: Front Side (front flap closed)

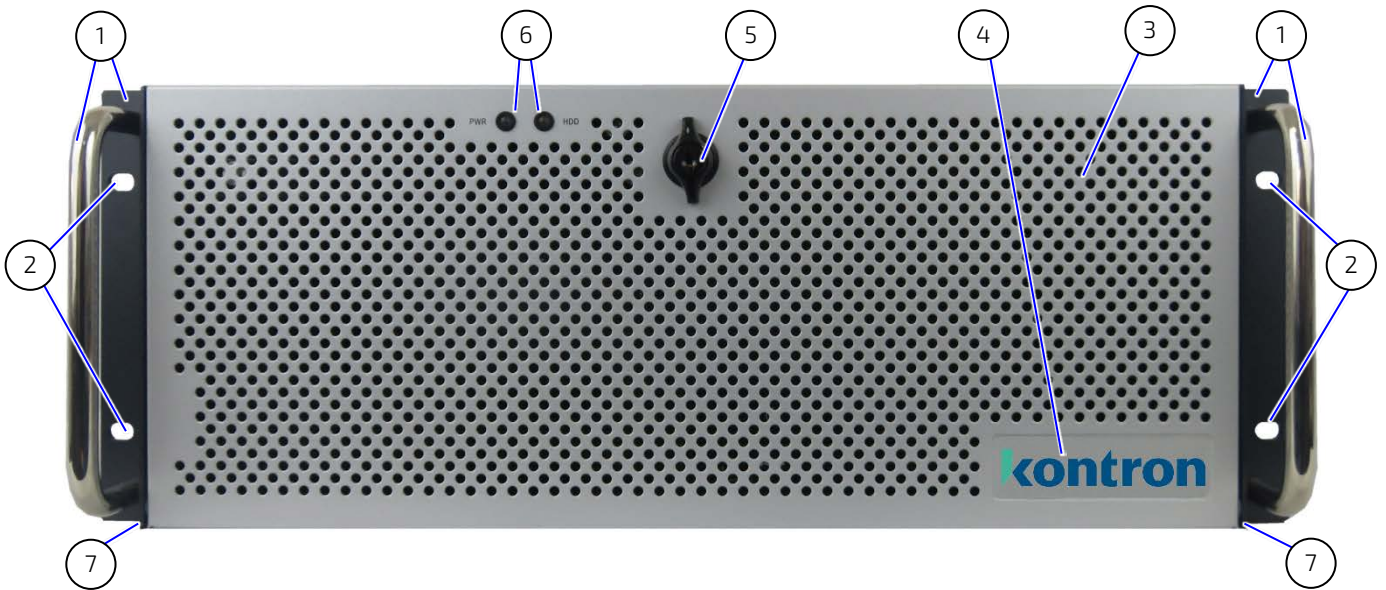

- | | |
|--------------------------------------|--------------------------------|
| 1. Handle bracket | 4. Kontron Logo |
| 2. Mounting holes for 19" racks | 5. Key lock for the front flap |
| 3. Front flap with ventilation holes | 6. LED indicators |
| | 7. Front flap side-plate |

The power button, LED indicators, two USB 3.2 Gen 1 ports, a filter pad holder and the integrated drives are located on the front side behind the front flap.

Figure 8: Front Panel (front flap open)

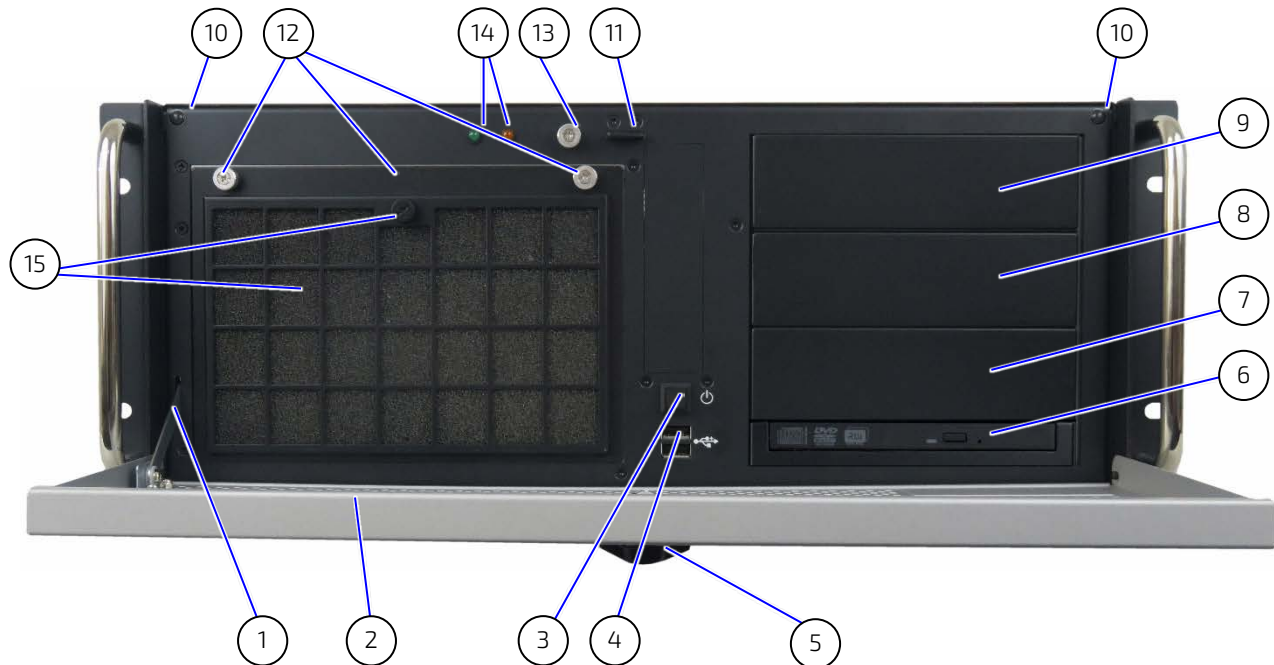

- | | |
|--|--|
| 1. Holder arm for the front flap | 8. D2: 5.25" drive bay for SATA HDD, SSD, DVD 5.25" drives |
| 2. Front flap with ventilation holes | 9. D1: 5.25" drive bay for SATA HDD, SSD, DVD 5.25" drives |
| 3. Power button | 10. Bump stop for the front flap |
| 4. 2x USB 3.2 Gen 1 | 11. Slot for the locking mechanism |
| 5. Securing lock mechanism (two keys provided) | 12. Fan assembly with two knurled screws |
| 6. D4: 3.5" drive bay for internal 2.5"/3.5" SATA HDD or front accessible slim DVD drive | 13. Cover fastening screw on the front side |
| 7. D3: 5.25" drive bay for SATA HDD, SSD, DVD 5.25" drives | 14. LED indicators |
| | 15. Filter pad holder with filter pad and knurled screw |

4.1.1. Front Flap

The front flap protects against unauthorized use. When locked the front flap can only be opened with a key and the drives, filter pad holder and power button are not accessible. To install or remove the front flap, see Chapter 7.5: Installing and Removing the Front Flap.



Front flap key must be kept safe and not be accessible to unauthorized persons.



If USB devices are connected to the USB ports on the front side, the front flap cannot be closed and locked

4.1.2. Drive Bays

The four drive bays drive bays D1, D2 and D3 are front accessible and drive bay D4 is either front accessible for slim drives or internally accessible for 3.5" SSD or HDD drives.

Figure 9: Drive Bays

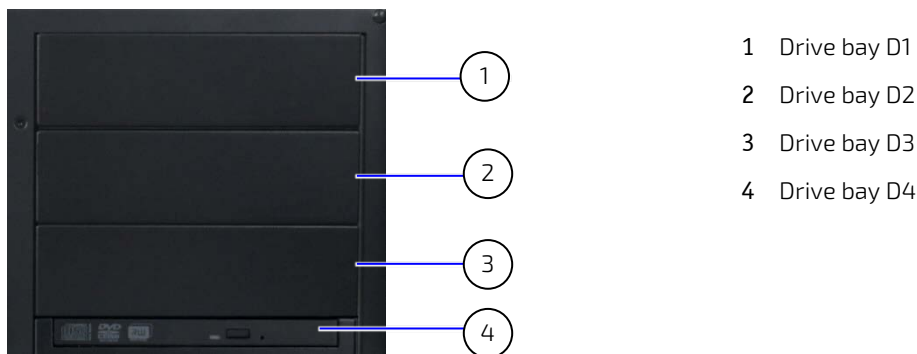

- 1 Drive bay D1
- 2 Drive bay D2
- 3 Drive bay D3
- 4 Drive bay D4

For additional storage, up to two M.2 2280 Key M SSD modules with NVME RAID are available, see Chapter 5/System Expansion.

4.1.3. Handle Brackets

For use on a desktop, remove both handle brackets (right side and left side), see Chapter 7.4: Installing and Removing the Handle Brackets. Attach the rubber feet (included in the delivery), see Chapter 7.6: Installing the Rubber Feet. Depending on the security requirements, the lockable front flap and two front flap side-plates can be removed or left in-place.

Figure 10: Handle Bracket

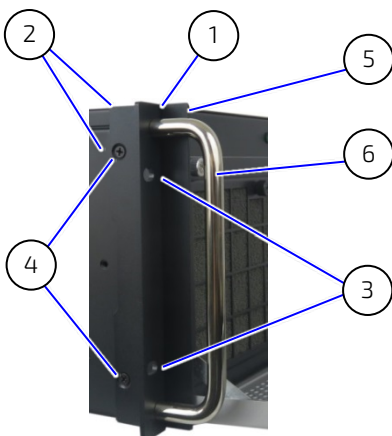

1. Handle bracket
2. Chassis and cover
3. Mounting holes for 19" racks
4. Screws to fasten handle bracket to chassis
5. Front flap side-plate
6. Handle

4.1.4. Fan Assembly

The two system fans are integrated in a user-friendly, replaceable slide-in fan assembly (hot-swap), mounted in a fan compartment on the front side. The two system fans are temperature controlled via temperature sensors, to provide airflow for optimal active cooling. For information on how to clean the filter pad, see Chapter 13.3: Cleaning the Filter Pad, or replace the fan assembly, see Chapter 13.4: Replacing the Fan Assembly.

Figure 11: Fan Assembly

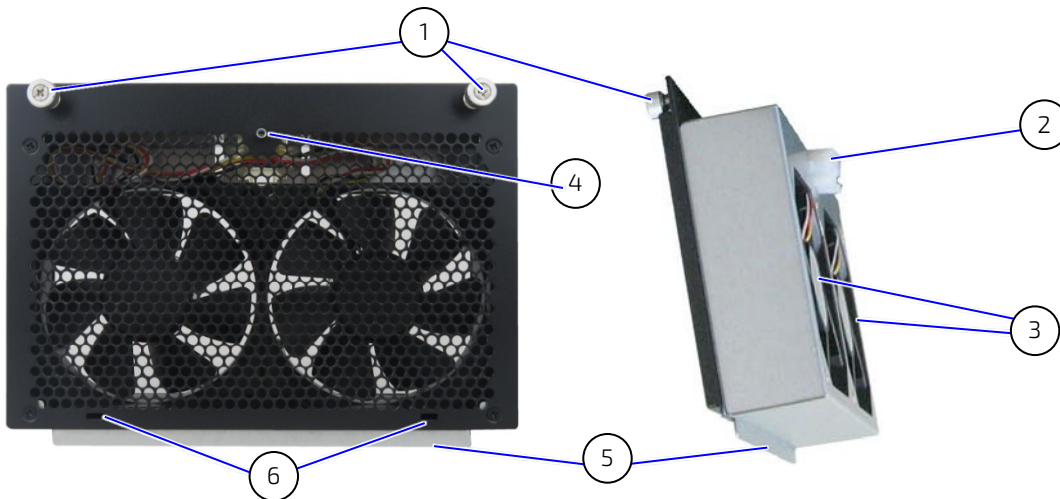

- | | |
|---|--|
| 1. Two knurled screws | 4. Bolt with tapped hole screw |
| 2. Connector for fan control | 5. Positioning bracket |
| 3. 2x fans (temperature controlled independently from each other) | 6. Positioning holes for the filter pad holder positioning latch |

⚠ CAUTION

Operation is permitted only with a functional fan assembly!
Replace a defective fan assembly only with an original fan assembly.

⚠ CAUTION

Fan assembly replaceable during operation
Replace fan only by qualified specialist or suitably instructed persons aware of the associated dangers. Keep hands and fingers away from rotating fan parts. Before removing the fan assembly, wait until the fans have totally stopped.



The fan assembly simplifies the installation and removal of the two system fans, and is hot-swappable, enabling the replacement of the fans even during operation.

4.1.5. Filter Pad and Filter Pad Holder

The filter pad and the filter pad holder are located behind the front flap. The filter pad protects the product from dust and dirt and will over time become soiled by pollution. If heavily soiled, the filter pad can cause excessive heating of the product. Kontron recommends cleaning the filter pad as often as necessary, see Chapter 13.3: Cleaning the Filter Pad.



The filter pad can be changed during operation.



The filter pad holder can be fastened to the front side of the fan assembly either before or after the fan assembly is installed in the chassis.

The filter pad inserts into the filter pad holder and then fastens onto the fan assembly's front side using two positioning latches (Figure 11, pos. 6) and the tapped hole bolt (Figure 11, pos. 4) on with the filter pad holder's knurled screw (Figure 8, pos. 15).

4.1.6. Power Button

The power button is located on the front side, behind the front flap. Press the power button to switch on and switch off the product. Pressing the power button for longer than four seconds initiates a forced system shutdown before switching off the power to the product.

Figure 12: Power Button



⚠ WARNING

AC Power cable and power connectors must always remain easily accessible.

The product is only completely disconnected from the mains power supply when the power cable is disconnected, from the mains power socket(s) or the product's input power socket(s). If the end environment restricts access to the power cable, disconnection must be guaranteed using a separate cut-off fixture.

⚠ WARNING

The power button does not disconnect from the mains power supply. When switched off using the power button, there is still a standby voltage of 5 VSB on the motherboard.

NOTICE

Performing a forced shutdown can lead to loss of data or other undesirable effects!

4.1.7. Power LED and HDD LED

The LED indicators are located on the front side, behind the front flap.

Figure 13: LED Indicators

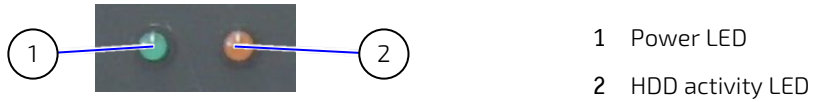

- 1 Power LED
- 2 HDD activity LED

Table 3: Power LED and HDD LED Activity

LED	Description
Power LED (PWR) (green)	Illuminates (green) when product is switched on by pressing the power button
HDD LED (orange)	Illuminates (orange) during hard disk activity

4.1.8. USB Ports

The two USB 3.2 Gen 1 ports are located on the front side, behind the front flap.

Figure 14: USB 3.2 Gen 1 Port



If USB devices are connected to the USB ports on the front side, the front flap cannot be closed and locked

4.2. Rear Panel

The rear panel features the PSU, air exhaust ventilation openings, the external interfaces and PCIe/PCI expansion card interfaces.



The PCIe expansion card slot allocation depends on the overall system configuration.

Figure 15: Rear Panel

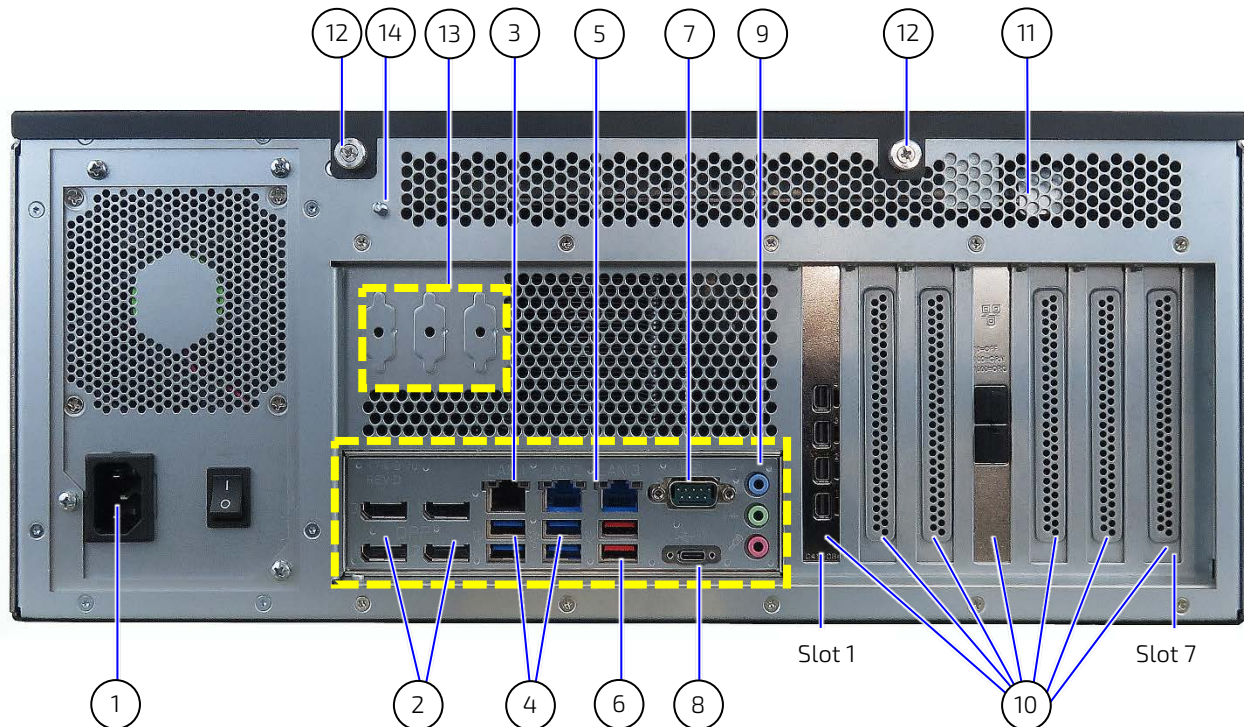

- | | | | |
|---|--------------------|----|--|
| 1 | Input power socket | 10 | Slot 1: PCIe x16, Gen 5, 16 lanes |
| 2 | 4x DP 1.4 @ 4K | | Slot 2: PCIe x1, Gen 3 (open slot) |
| 3 | 1x 1.0 GbE | | Slot 3: PCIe x16, Gen 4, 4 lanes |
| 4 | 4x USB 3.2 Gen 1 | | Slot 4: PCIe x8, Gen 4, 4 lanes |
| 5 | 2x 2.5 GbE | | Slot 5: PCIe x8, Gen 4, 4 lanes (open slot) |
| 6 | 2x USB 3.2 Gen 2 | | Slot 6: PCIe x1, Gen 3 (open slot) |
| 7 | 1x COM (RS232) | | Slot 7: PCI 32 bit |
| 8 | 1x USB-C 3.2 Gen 2 | 11 | Ventilation openings |
| 9 | 1x Audio | 12 | Two Knurled screws |
| | | 13 | 3x Breakouts optional interfaces routed to the rear (9-pin D-SUB type connector) |
| | | 14 | Potential equalization stud |

4.2.1. Display Port (DP)

The four Display Ports are DP V1.4a @4K. All DisplayPort outputs are equivalent and compatible with DP++ and support a resolution of 4096x2160 @ 60Hz. The display resolution may vary depends on the number of simultaneous displays.

Table 4: Display Resolution

Common Screen Resolution (max.)	Number of Simultaneous Displays
8k @ 60 Hz HDR 5k @ 120 Hz HDR	1
8k @ 60 Hz SSR 5k @ 60 Hz HDR	2
4k @ 60 Hz HDR	4

If the multi-monitor output is enabled, the screen output is shown on two displays simultaneous (clone view). Depending on the DP used, only two displays are selected if more than two monitors are connected. The lowest numerical "Priority" wins, as shown in Table 5: Display Order Priority.

Table 5: Display Order Priority

Priority	1	2	3	4	5	6
Primary Display	DP1	DP1	DP1	DP2	DP2	DP3
Secondary Display	DP2	DP3	DP4	DP3	DP4	DP4

Connection to either a VGA, DVI or HDMI video source is possible using either a passive or active adapter. The type of adapter depends on the signal type and if the connection is to a single device or multiple devices.



DP adapters:

- DP to HDMI (passive/active)
 - DP to DVI (passive/active)
 - DP to VGA (active)
-

4.2.2. USB 3.2

All USB 3.2 connectors provide separate signal lines for USB 3.2 and USB 2.0.

4.2.3. LAN

The 1.0 GbE LAN port features:

- ▶ i219LM LAN controller
- ▶ IEEE 802.3 specification for 1000BASE-T, 100BASE-TX, 10BASE-T
- ▶ iAMT features
- ▶ Wake on LAN
- ▶ Link Status change and Magic Packets™, PXE support
- ▶ BIOS MAC address display
- ▶ Teaming support

The two 2.5 GbE LAN ports feature:

- ▶ i225LM LAN controller
- ▶ IEEE 802.3 specification for 2500BASE-T, 1000BASE-T, 100BASE-Tx, 10BASE-TE
- ▶ TSN support
- ▶ Wake on LAN
- ▶ Link Status change and Magic Packets™
- ▶ PXE support
- ▶ BIOS MAC address display
- ▶ Teaming support



The 2.5 GbE LAN "Activity LED" remain active even if the LAN controller is disabled in the BIOS Setup.



Linux Shutdown Issue

If 2.5 GbE LAN ports are enabled, a shutdown or suspend may result in a CAT Error, related to the PTM function of the internal i225 Ethernet controller. For workaround information, contact [Kontron Support](#).

4.2.4. Audio

The Audio ports support Line-in, Microphone and Headphone Output.



For technical data, refer to the motherboard's user guide [K3851-R ATX](#)

4.2.5. Serial Ports (COM)

The product design enables the routing of on-board interfaces such as serial ports to the rear panel.



For technical data, refer to the motherboard's user guide [K3851-R ATX](#)

4.2.6. Power Supply Units

The Power Supply Unit (PSU) is located on the rear side and supplies the required internal voltages using standard certified cabling. For the PSU power specification, see Table 14: Electrical Specification.

⚠ WARNING

Energy hazards -240 VA present in the chassis

To switch off the product properly and ensure no energized internal parts, switch off the product using the power button on the front panel and disconnecting the product's power cable from the input power socket(s) or the mains power supply socket(s).

⚠ WARNING

Easy Access to Power Cable and Power Connectors

The power cable must always remain easily accessible. If the operating environment restricts power cable access, disconnection must be guaranteed using a separate cut-off fixture.

⚠ WARNING

Operate closed

Operate only with a closed and secured cover, to ensure that operators do not have access to energized internal parts.

⚠ WARNING

Only use the AC power cable delivered with product and sufficiently rated for the implemented power supply.

⚠ WARNING

Ensure that the mains power supply socket is grounded and the power cable is in perfect condition with no visible damage.

NOTICE

The rated mains voltage range must agree with the voltage specified on the type label.

NOTICE

Do not disconnect the power from the product while the product is switched on!
Performing a forced shut down can lead to loss of data or other undesirable effects!

The default PSU is a single 600 W PSU with the option for a redundant 500 W PSU for high availability applications. Both PSUs support a nominal input voltage of 100 VAC to 240 VAC.

Figure 16: Single PSU (600 W)

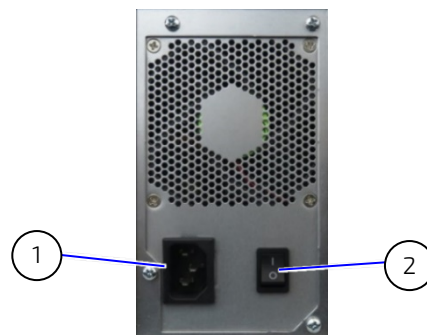

1. Input power socket (Single PSU)

2. PSU On/Off (single PSU)

The redundant PSU contains two separate PSUs each capable of powering the product alone and each supplied using a dedicated power cable connection to the mains power supply. To ensure the power cables are not accidentally removed from the input power sockets, the power connector is held firmly in place by a cable holder.

Figure 17: Redundant 500 W PSU

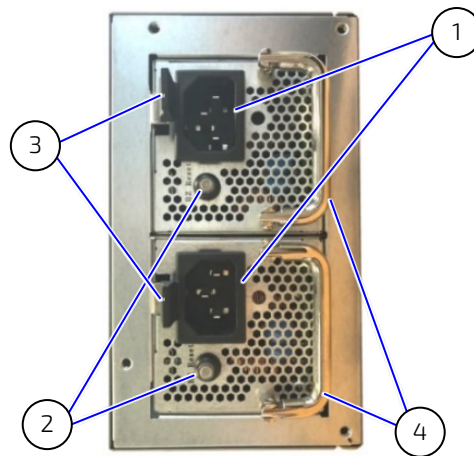

- | | |
|--|---------------------------------|
| 1. Input power socket | 3. Power cable holder |
| 2. Buzzer reset switch with indicator LED
Power | 4. Removal and insertion handle |

If a PSU fails, the faulty PSU shuts down and the indication LED changes color from green (active) to red (faulty), to indicate which PSU is faulty. The functional PSU takes over the full operation, until the faulty PSU is replaced, see Chapter 13.5: Replacing the Faulty Redundant PSU.

Table 6: Redundant PSU LED Description

PSU LED	Buzzer	Power Supply Description
Green	Off	PSU output ON and AC present
OFF	Off	No AC power to all PSU
Green (Flashing)	Off	AC present and PSU off
Red (flashing)	On	Main AC power cable unplugged or AC power lost; with a second power supply in parallel still with AC input power.
Red (Flashing)	Off	Power supply warning events where the power supply continues to operate, such as: high temperature, high power, high current, slow fan.
Red	On	Power supply critical event causing a shutdown; failure, such as: OCP, OVP, UVP

4.2.7. Potential Equalization Stud

The potential equalization stud is located on the rear side (Figure 15, pos. 9). The potential equalization stud is not a ground connection. The potential equalization stud can be connected to ensure that all connected system have the same potential.



The potential equalization stud is not a ground connection! The potential equalization stud ensures that all connected systems share a common potential.

4.2.8. PCIe/PCI Expansion Card Slots

The PCIe/PCI expansion card slots support six PCIe expansion cards and one PCI expansion card.

For the PCIe/PCI slot allocation, see Table 9: PCIe/PCI Expansion Card Slots.



For PCIe/PCI slot functionality and location information, refer to the motherboard's user guide, [K3851-R ATX](#)

4.3. Side

On the left and right sides are, six M4 tapped screw holes used for installation in a 19" industrial rack with slide rails.

Figure 18: Left Side

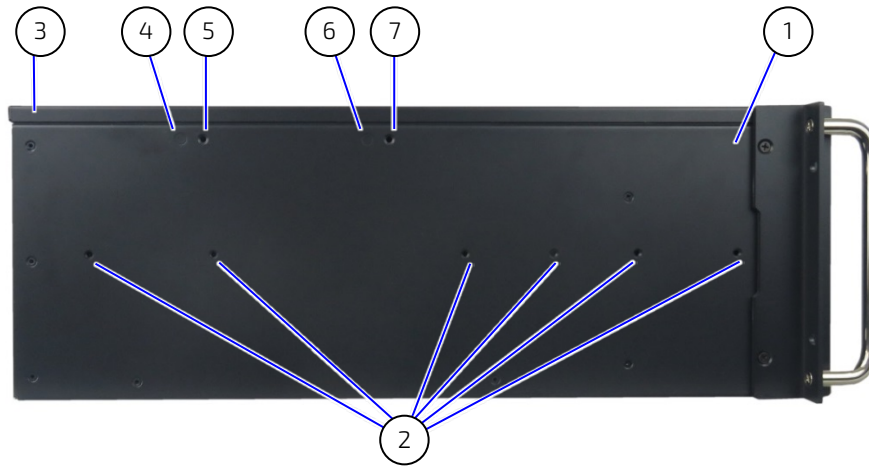

- | | |
|---|---|
| <ol style="list-style-type: none"> 1. Left side view of a KISS 4U V3 chassis 2. 6x M4 tapped holes (on both sides) 3. Cover 4. Internal bolt for long bracket for full-length expansion cards | <ol style="list-style-type: none"> 5. Externally accessible screw (countersunk screw M3x6) for long bracket for full-length expansion cards 6. Internal bolt for short bracket for half-length expansion cards 7. Externally accessible screw (countersunk screw M3x6) for short bracket for half-length expansion cards |
|---|---|

Figure 19: Right Side

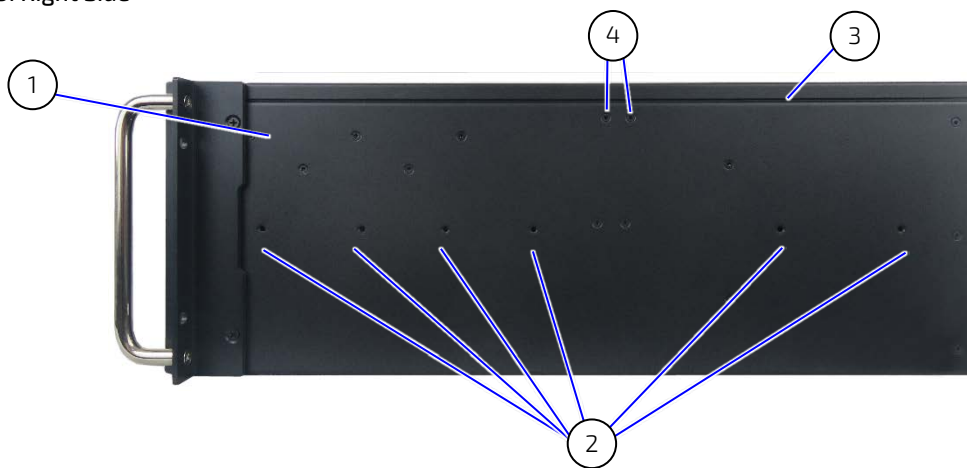

- | | |
|---|--|
| <ol style="list-style-type: none"> 1. Right side view of a KISS 4U V3 chassis 2. 6x M4 tapped holes (on both sides) | <ol style="list-style-type: none"> 3. Cover 4. Screws for internal card hold down bracket for long expansion cards (full-length) |
|---|--|

4.4. Cover

The cover is secured to ensure that operators do not have access to energized internal parts. To open the top cover, see Chapter 7.2: Opening and Closing the Cover.

⚠ WARNING

Energy hazards-present inside the chassis!

Before removing the top cover, switch off the product properly by using the power button on the front side and disconnecting the power cable(s) from the mains power supply(s).

⚠ WARNING

Intended used is closed

Use only with a closed and secured cover, to ensure that operators do not have access to energized internal parts.

The cover fixes to the chassis using two fixing brackets on the front side of the cover (Figure 20, pos. 3 and pos. 4), and fastens using two knurled screw on the rear side (Figure 20, pos. 6) and one knurled screw (Figure 8, pos. 13) on the front side of the cover. For information on how to open the cover, see Chapter 7.2: Opening and Closing the Cover.

Figure 20: Cover Underside

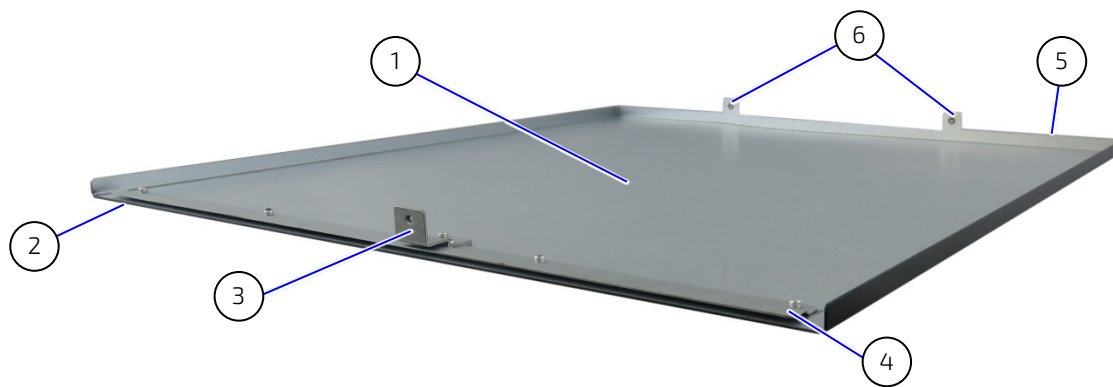

- | | |
|--|---------------------------------------|
| 1. Underside of cover | 4. Fixing bracket (on the front side) |
| 2. Cover front side | 5. Cover rear side |
| 3. Angulated centering fixing bracket with tapped hole (on the front side) | 6. Two knurled screws |

4.5. System Configuration

Figure 21: Example of KISS 4U V3 ADL Configuration

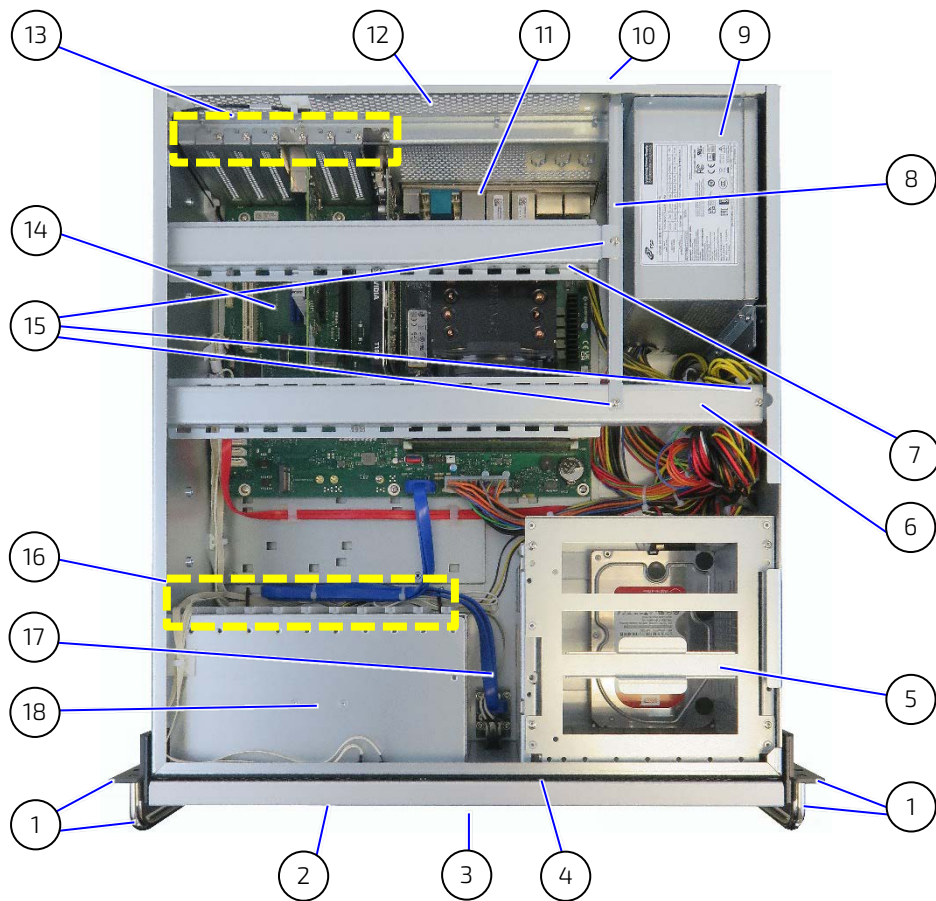

- | | |
|---|--|
| 1. 19" rack mountable bracket with handle | 9. Power supply unit (PSU) |
| 2. Front flap | 10. Potential equalization stud |
| 3. Access panel lock | 11. External interfaces of the motherboard |
| 4. Cover retaining plate on the front side | 12. Ventilation holes (air exhaust) |
| 5. D1, D2, D3 and D4 : Drives (stacked one above the other in a drive cage) | 13. Slots for expansion cards with fastening screw. |
| 6. Long bracket (for full-length expansion cards) | 14. ATX motherboard |
| 7. Short bracket (for half-length expansion cards) | 15. Fastening screw for the card hold down bracket (internal accessible) |
| 8. Retaining bracket for the card hold down bracket | 16. Card guides (for full-length cards) |
| | 17. Optional 3.5" drive bay (breakout on front panel) shown empty here. |
| | 18. Fan compartment (containing fan assembly) |

5/ System Expansion

This chapter contains important information on how to expand the KISS 4U V3 ADL with storage and expansion cards.

5.1. Before Expanding

Before expanding the product with storage and expansion cards, consider the maximum power consumption allowed by the power supply.



Due to the limited lifespan of expansion devices, Kontron recommends checking the condition of installed expansion devices regularly and to pay attention to the manufacturer's lifespan specifications.

5.2. Mass Storage (Internal)

The internal mass storages option supports up to two M.2 2280 Key M SSD modules supporting NVME RAID.

Table 7: Mass Storage Devices

Mass Storage	Quantity	Interface	Description
M.2 2280 Key M SSD Module	2	NVME	Up to 4 TByte NVME RAID support



The two M.2 2280 SSD support NVME RAID support.

5.3. Drive Bays

The three drive bays D1, D2 and D3 are populated with front accessible removable drives within an internal open drive-cage. Drive bay D4 is populated either with a front accessible slimline CD/DVD or if the slimline CD/DVD is not installed this drive bay may be used for an internal 2.5" or 3.5" HDD or SSD drive.

The four drive bays supports separate drives or configuration as a RAID array using the motherboard's chipset RAID (0/1/5). RAID support requires a minimum of two SDD/HDD removable drives.

Table 8: Drive Bays

Drive Bay	Location	Description
D1	Front accessible	One 5.25 " drive bay for SATA HDD, SSD, DVD drives
D2		One 5.25" drive bay for SATA HDD, SSD, DVD drives
D3		One 5.25" drive bay for SATA HDD, SSD, DVD drives
D4	Front accessible	One slim drive bay for slim DVD drives
	Internal	One 3.5" drive bay for 2.5" or 3.5" SATA SSD, HDD drives



For RAID information, refer to the motherboard's chipset specification for the RAID type and Intel® Rapid Storage Technology availability.



RAID support requires a minimum of two HDD/SSD removable drives.

5.4. Expansion Cards

The expansion card slots support up to six PCIe slots and one PCI slot.

Table 9: PCIe/PCI Expansion Card Slot Allocation

Expansion Card Type	Slot #	Slot Type (full height, full length)	Description
PCIe	1	PCIe x16 Gen 5, 16 lanes	Default slot for reference GPU expansion cards full height, full length, 75 W max. load
	2	PCIe x1 Gen 3 (open slot)	full height, full length, 25 W max. load
	3	PCIe x16 Gen 4, 4 lanes	full height, full length, 75 W max. load
	4	PCIe x8 Gen 3, 4 lanes	Default slot for reference LAN expansion cards full height, full length, 25 W max. load
	5	PCIe x8 Gen 4, 4 lanes (open slot)	full height, full length, 25 W max. load
	6	PCIe x1 Gen3 (open slot)	full height, full length, 25 W max. load card
PCI	7	PCI 32 Bit	full height, full length, 10 W max. load



For PCIe/PCI slot functionality and location information, refer to the motherboard's user guide, [K3851-R ATX](#)



Before expanding the product with additional PCIe/PCI cards, observe that the specified maximum power consumption supported by the PSU is not exceeded.

5.4.1. Reference PCIe Expansion Card

The Kontron reference full height PCIe expansion cards support the following functions:

Table 10: Reference KISS 4U V3 ADL PCIe Expansion Cards

Reference Card	Description
LAN Dual 1.0 GbE Copper Port	Speed: 10/100/1000Mbps Bus type: PCIe* V2.1 (5 GT/S) Bus width: x4-lane PCIe (operable in x4, x8 and x16 slots) Ethernet controller: Intel® I350 Connector: 2x RJ45 Power consumption: 4.4 W
LAN Dual 10 GbE Copper Port	Speed: 10GBE/1GBE/100Mbps Bus type: PCIe V3.0 (8.0 GT/S) Bus width: x4-lane PCIe (operable in x8 and x16 slots) Ethernet controller: X550AT Connector: 2x RJ45

Reference Card	Description
	Power consumption: 11.2 W (typ.), 13 W (max.) LEDS: <ul style="list-style-type: none"> ▶ Link (Green/Orange); Activity (Green flashing) ▶ Link rate (Green 10 Gbps; Orange 1 Gbps/100 Mbps)
LAN Quad 1 GbE Copper Port	Speed: 10/100/1000Mbps Bus type: PCIe V2.1 (5 GT/S) Bus width: x4-lane PCIe (operable in x8 and x16 slots) Ethernet controller: Intel® I350 Connector: 4x RJ45 Power consumption: 5.04 W LEDS: <ul style="list-style-type: none"> ▶ Link (Green/Orange); Activity (Green flashing) ▶ Link rate (Green 10/100Mbps; Orange 1000 Mbps)
Graphics Card Quad DP	4x DP1.4 Connector: 4x miniDP with latching mechanism Interface: PCIe 3.0 x16 Form factor: Single slot Power consumption: 40 W Max. simultaneous displays: <ul style="list-style-type: none"> ▶ 4x 3840x2160@120Hz ▶ 4x 5120x2880@60Hz ▶ 2x 7680x4320@60Hz

Others PCIe/PCI expansion card options are available on request. For more information, contact [Kontron Support](#).

6/ Thermal Management

This chapter contains important information on how to manage KISS 4U V3 ADL thermal considerations.

6.1. Active Cooling

Two system fans within the fan assembly force air to flow through the ventilation holes from the front to the back of the chassis. The processor and expansion cards have integrated cooling solutions or are equipped with corresponding cooling devices. The fan assembly's filter pad protects against contaminants such as dust and dirt entering the product and will overtime become clogged by contaminants. When clogged, the filter pad restricts the amount of air entering the product thus causing excessive heating. Kontron recommends cleaning the filter pad as often as necessary, see Chapter 13.3: Cleaning the Filter Pad.

CAUTION

Clean the filter pad when clogged by contaminants to ensure adequate ventilation. The required regularity depends on the level of contaminants within the operating environment.

CAUTION

Operation is permitted only with functional system fans!
Replace a defective fan only with a Kontron fan spare part.



The fan assembly simplify the installation and removal of the two system fans, and is hot-swappable, enabling the replacement of the fans even during operation.

6.2. Temperature Sensor

The temperature conditions of the product depend on the environmental temperature and the load. Two internal temperature sensors detect the temperature and control the speed of the system fans accordingly.

6.3. Minimum System Clearance

To provide maximum airflow observe a minimum clearance at the front and rear sides of the product to the surrounding environment must be observed. To guarantee that sufficient air flows from the front to the back of the chassis, ensure that the ventilation holes are not covered, blocked or obstructed by surrounding parts.

Before installing the product, take into account any thermal considerations, such as minimum clearance, airflow obstructions and the correct mount orientation.

CAUTION

Ensure Sufficient Airflow

Ensure that the 19" rack cabinet is well ventilated and does not prevent the product from taking in air at the front and exhausting air at the rear.

CAUTION

Leave a sufficient clearance to ensure maximum airflow and prevent overheating!

CAUTION

Do not place the product close to heat sources or damp places.



There are no ventilation restrictions above and below the product, enabling installation directly on top of or below another system.

6.4. Third Party Components

When expanding with third party components such as PCIe/PCI expansion cards, M.2 modules, DIMMs and drives (HDD, SSD, DVD); take into consideration that there is an increase in air temperature inside the chassis and the air temperature in the chassis is higher than the ambient air temperature around the product.

7/ Assembly

This chapter contains important information on the mechanical assembly and working safely with internal components. Follow these instructions when handling KISS 4U V3 ADL internal components and observe the corresponding safety instruction included in Chapter 2/: General Safety Instructions.

7.1. Before Assembling the Product

Before installing external accessories to the product read the instruction within the user guide and always use the screws provided with the mechanical part.

⚠ WARNING

Energy hazards-present inside the chassis!

Before removing the top cover. Switch off the product properly using the power button and disconnecting the power cable(s) from the mains power supply(s).

⚠ WARNING

Ensure the cover is secure and the metal catches (right side & left side) are in the lock hole before switching on the product.

⚠ WARNING

Activities requiring internal access of the product must be performed by trained personnel aware of the associated dangers!



ESD Sensitive Device!

Follow the safety instructions for components that are sensitive to electrostatic discharge (ESD). Failure to observe this warning notice can result in damage to the components.

7.2. Opening and Closing the Cover

To open the cover no special tools are required. The cover is secure using three knurled finger screws.

⚠ WARNING

Intended used is closed

Use only with a closed and secured cover, to ensure that operators do not have access to energized internal parts

To open the cover, proceed as follows:

1. Switch off and disconnect the product from the mains power supply.
2. Loosen the cover's knurled screws on the front side (Figure 22) and the two knurled screws on the rear side (Figure 23) that secure the cover.

Figure 22: Loosening Knurled Screw (front panel)



Figure 23: Loosening Knurled Screws (rear panel)

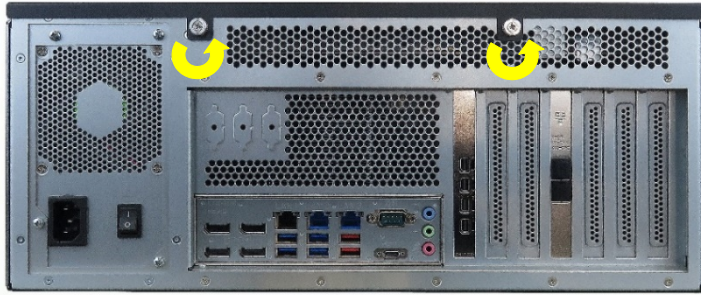

3. Pull the cover out slightly as shown in Figure 24 to release the cover's centering and fixing brackets (Figure 20, pos.3 and pos. 4) from the retaining brackets of the chassis (Figure 21, pos. 4).

Figure 24: Pull and Release the Cover



4. Lift the cover up (on the rear edge) and remove the cover as shown in Figure 25 .

Figure 25: Removing the Cover



5. To close and secure the cover, proceed in the reverse order (step 4 to step 2).

⚠WARNING

Close properly using all knurled screws!

- One front side knurled screw
 - Two rear side knurled screws
-



When sliding the cover back onto the chassis, it may be required to lift the middle of the cover to enable the cover's four pins to slide onto the corresponding front plate holes.

7.3. Installing and Removing PCIe/PCI Expansion Cards



Consult the documentation provided by the expansion card's manufacturer for instructions before installing/removing the expansion card.



Insert a blank slot bracket into an empty expansion card slot and secure with screw

The PCIe/PCI expansion cards are secured on the rear side and internally using the internal long and short brackets with PCB holder (Figure 26). Installing or removing PCIe/PCI expansion cards may require the removal of the long and/or short brackets.



To install a half length expansion card, remove only the short bracket (Figure 21, pos. 7).

To install or remove an expansion card, perform the following steps:

1. Switch off and disconnect the product from the mains power supply.
2. Open the cover as described in Chapter 7.2: Opening and Closing the Cover.
3. Locate the long and short brackets (Figure 21, pos. 6, pos. 7) that hold down the expansion cards and the slot brackets (Figure 21, pos.13) , that secure the expansion cards to the corresponding rear side expansion slots.

Figure 26: Short and Long Brackets, and PCB Holder

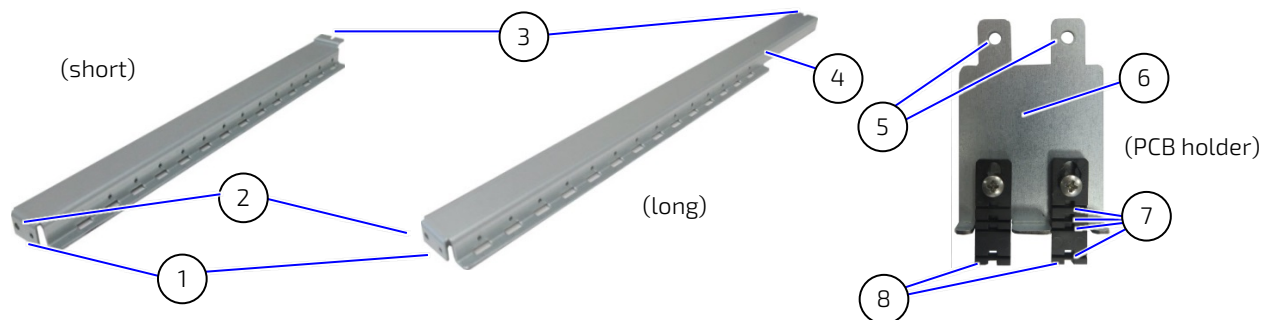

- | | |
|--|--|
| 1. Threaded holes for the externally accessible fastening screws (Figure 18, pos. 5 & 7) | 5. Screw holes to fasten to card hold down bracket |
| 2. Holes for internal bolts (Figure 18, pos. 4 & 6) | 6. Metal bracket to fasten to card hold down bracket |
| 3. Notches for fastening screws to secure card hold down brackets to the internal brackets | 7. PCB holder (with adjustable break off ridges) |
| 4. Threaded hole to attach retaining bracket | 8. PCB holder notch |

4. To remove the short bracket:
 - a. Loosen the internal and then the externally accessible fastening screws that secure the short bracket (Figure 21, pos. 7) to the chassis, (Figure 27 , step 1 and 2).

- b. Pull the short bracket to the left (Figure 27, step 3) to detach the short bracket from the sideways mounted bolts.
- c. Lift the short bracket out of the chassis (Figure 27, step 4) and retain for later use with screws.

Figure 27: Steps to Remove/Install the Short and Long Brackets

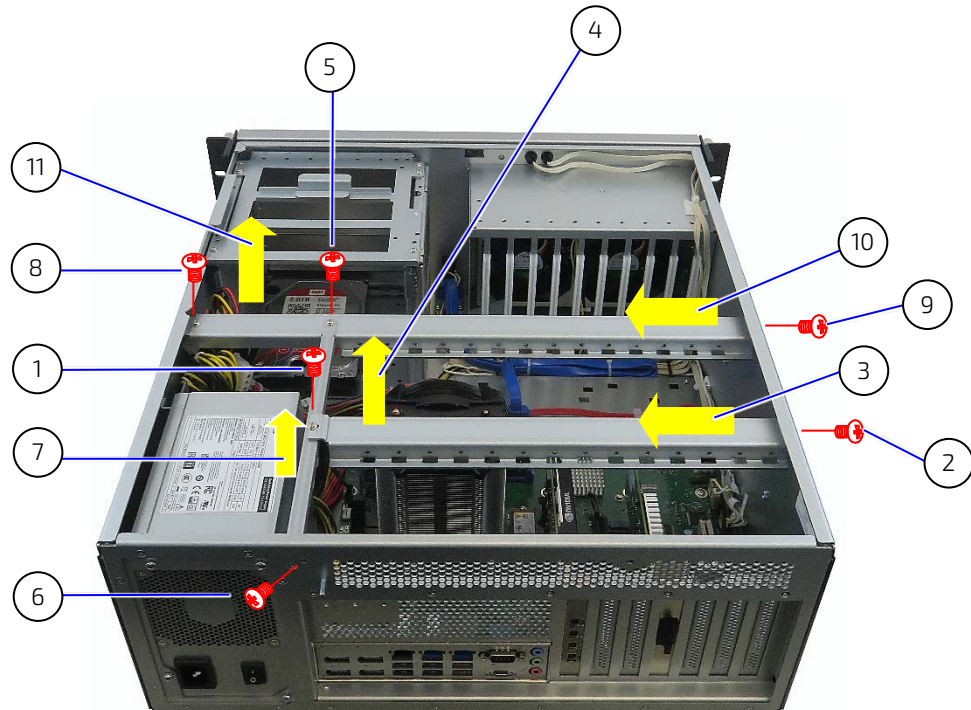

5. To remove the retaining bracket:
 - a. Loosen the internal and then the externally accessible fastening screw that secure the retaining bracket (Figure 21, pos. 8) to the chassis, (Figure 27, step 5 and 6).
 - b. Lift the retaining bracket out of the chassis (Figure 27, step 7) and retain for later use with screws.
6. To remove the long bracket:
 - a. Loosen the internal and then the externally accessible fastening screws that secure the long bracket (Figure 21, pos. 6) to the chassis, (Figure 27, step 8 and 9).
 - b. Pull the long bracket to the left (Figure 27, step 10), to detach the long bracket from the side mounted bolts.
 - c. Lift the long bracket out (Figure 27, step 11) and retain for later use with screws.
7. Install/remove the expansion card into/from the expansion card slot on motherboard and fasten the expansion card bracket to the slots bracket on the rear side of the chassis (Figure 21, pos. 13)
8. Reinstall the long, retaining and short brackets with the screws retained in steps 4c, 5b and 6c and proceeds in the reverse order by:
 - a. Initially, tighten the screws half way only.
 - b. Firmly tighten the externally accessible screws (Figure 27, steps 9, 2 and 6)
 - c. Firmly tighten the screws at the notches that secure the long, retaining and short brackets (Figure 27, steps 1, 5 and 8)

9. To keep expansion card firmly in place during high mechanical load (shock and vibrations) PCB holders (Figure 26) are used to stabilize the expansion cards (especially long expansion cards).
To install or remove a PCB holder:
- Fix the upper edge of the expansion card (especially with long expansion cards) into the required notch of the PCB holder (Figure 26, pos. 8) by adjusting the PCB holder's height by break of the unrequired ridges of the plastic notch strip.
 - Securely fasten the PCB holder (Figure 26, pos. 5) to the long/short bracket.
 - To remove the PCB holder proceed in the reverse order by first releasing the PCB holder from the long/short bracket and then releasing the PCB holder's notch (Figure 26, pos. 8) from the top side of the installed expansion card.
10. Close the cover as described in Chapter 7.2: Opening and Closing the Cover.

7.4. Installing and Removing the Handle Brackets

The two handles brackets (left and right side) are removable.

Figure 28: Removing the Handle Brackets

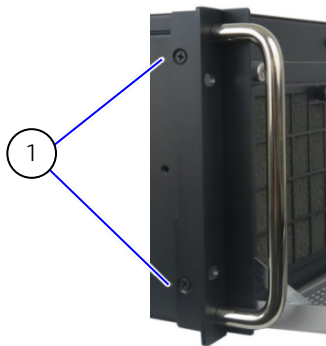

1. 2x Bracket handle screws

To remove the two handles brackets, proceed as follows:

1. Loosen and remove the two screws (Figure 28, pos. 1) that fasten the handle brackets (left side, right side).
2. Remove the handle bracket and store with fastening screws for possible further use.
3. To reinstall the handle brackets proceed in the reverse order (step 1 to 2).



The product is supplied with assembled handle brackets.

7.5. Installing and Removing the Front Flap

The front flap and the two front flap side-plates are removable.

Figure 29: Front Flap Side-plate (left and right)

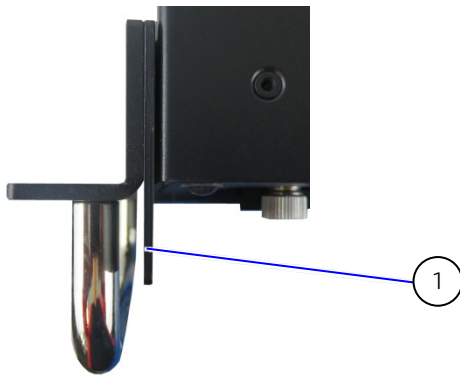

1. Front flat side-plate (left and right)

To remove the front flap and the two front flap side-plates, proceed as follows:

1. Remove the handle brackets as described in Chapter 7.4: Removing the Handle Brackets (steps 1-2) and retain the handle bracket and screws for future use.
2. Loosen the two screws that hold the front flap side-plates (Figure 29, pos. 1) to chassis (left and right).
3. When loosened the front flap hinges can be removed from the front flap side-plate's opening by initially releasing one side of the front flap the loosening and removing the other side.
4. Guide the front flap's holder arm out of holding slot (Figure 8, pos. 1).
5. Store the front flap for future use.
6. Tighten the loosened screws (step 2) that hold the front flap side-plates in position or remove the front panel side-plates (left side and right side) by removing the two screws previously loosened in step 2
7. If required install the handle bracket as described in Chapter 7.4: Removing the Handle Brackets (step 3).



The product is supplied with the front flat assembled.

7.6. Installing the Rubber Feet (option)

For use on a desktop, to avoid scratching the surface, attach the supplied four rubber feet. To install the rubber feet, proceed as follows:

1. Switch off the product and disconnect it from the mains power supply. Disconnect all peripherals.
2. Ensure that all expansion cards are secure and the cover is closed.
3. Turn the chassis upside down (Orientation bottom side facing upwards).
4. Remove the protective film from the self-adhesive rubber feet and attach to the bottom side of the chassis.
5. Turn the chassis the right way around (Orientation: cover facing upwards).

7.7. Installing Slide Rails (option)

Kontron offers a 19" Slide Rails and Rack Slide Rails Kit. For more information, see Table 2: Accessories and Spares Parts.

⚠ CAUTION

To support the products weight, two separate fixation methods must be used:

- Front handle brackets (right side and left side)
- Slide rails or L brackets or a 19" rack rear side fixation

⚠ CAUTION

Use only the screws provided to attach the telescope slide rails.

⚠ CAUTION

Verify secure mounting

Mount using the slides rails on the left and right sides and ensure the front handle brackets are fastened to the left and right sides of the 19" Industrial rack cabinet.

To install slide rails, proceed as follows:

1. Extend the slide rail to the pulled-out position to expose the inner part of the slide rail with screw holes (Figure 30, pos. 2).
2. Using the supplied screws firmly attach the side rail to the left side and right side. (Figure 30, pos. 2).
3. Push the slide rail into the pushed-in position (Figure 32).
4. Install the corresponding rack slide rail kits to the 19" industrial rack cabinet, see Figure 33: Assembling the Slide Rails in an Industrial Rack Cabinet

Figure 30: Slide Rail Inner Part

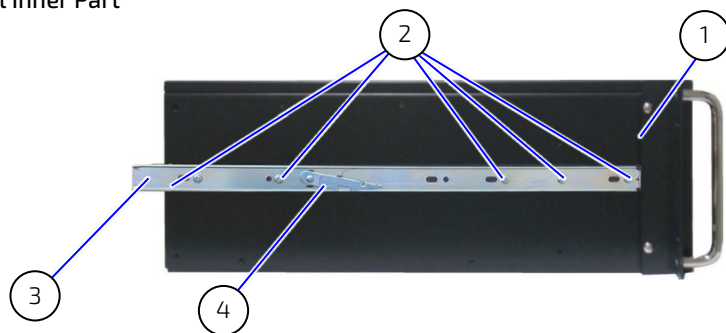

- | | |
|---|---------------------------------|
| 1. Side | 3. Inner part of the slide rail |
| 2. 6x M4 rounded head screws(per each side) | 4. Locking/unlocking lever |

Figure 31: Slide Rail in Pulled-out Position

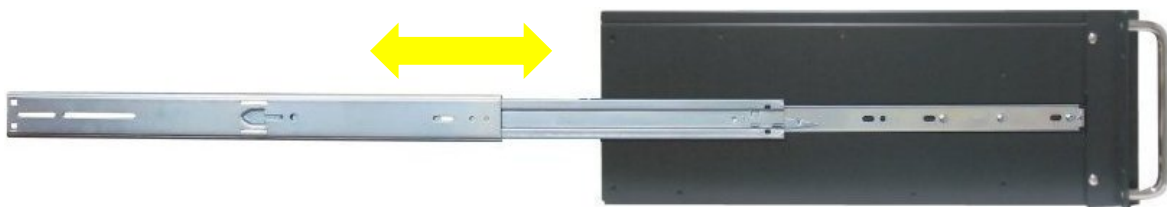
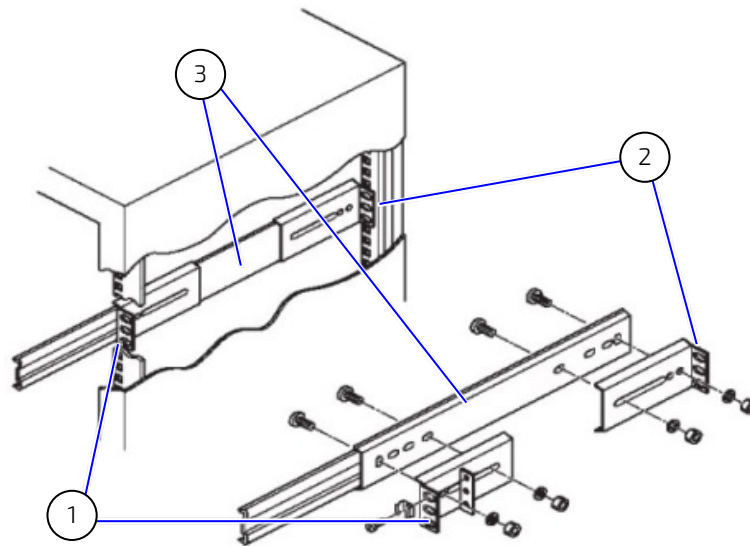

Figure 32: Slide Rail in Pushed-in Position



Figure 33: Assembling the Slide Rails in an Industrial Rack Cabinet



- | | |
|--|--|
| <ol style="list-style-type: none"> 1. Short front rack bracket 2. Long rear rack bracket | <ol style="list-style-type: none"> 3. Telescopic slide rail attached to Industrial rack cabinet |
|--|--|



Short rack brackets are used at the front of the chassis and long rack brackets at the rear.

8/ Installation

This chapter contains important information on how to mount the KISS 4U V3 ADL in a 19" Industrial rack and in customer specific environments.

8.1. Before Installing

Before installing the product, read the installation instructions within this chapter and observe the information in Chapter2/General Safety Instructions. Due to possible access restrictions, install all expansion cards and connect all peripherals before mounting the product.

⚠ WARNING

The product must be installed only by trained personnel aware of the associated dangers.

⚠ WARNING

Ensure sufficient air circulation

Ensure the product is well ventilated and that nothing obstructs the product from taking in air at the front and exhausting air at the rear.

⚠ WARNING

Do not place the product close to heat sources or damp places.

⚠ CAUTION

Due to the products weight, mounting the product alone may result in damage to the product or personal injury.

⚠ CAUTION

Before connecting any I/O cables. Ensure that the product is switched off and the power cable(s) is disconnected connected from the power connector or mains power(s).

⚠ CAUTION

Mounting options for operated are horizontally and vertically

⚠ CAUTION

When connecting cables, following proper cabling procedures:

1. Grounding pin is connected first and disconnected last
2. Connect all I/O cables
3. Power connection is the last connection



The product is designed for horizontal operation. Vertical operation is possible.



Due to possible access restrictions, before installing the product install all expansion cards and connect required peripherals to the corresponding system port.

8.2. Installing as a Desktop

Before installing the product in a desktop environment, install the delivered rubber feet, to avoid scratching the installation surface. Additionally, observe the general instructions and any safety warnings within this chapter.

⚠ WARNING

Voltage feeds must not be overloaded

Adjust the cabling and the external overcharge protection to correspond with the electrical data indicated on the type label located on right side of the chassis.

⚠ WARNING

Ensure sufficient air circulation

Ensure that nothing obstructs the product from taking in air at the front and exhausting air at the rear.

To install in a desktop environment, proceed as follows:

1. Add the rubber feet as described in Chapter 7.6: Installing the Rubber Feet.
2. If required, remove the handle brackets as described in Chapter 7.4 :Removing the Handle Brackets
3. If required remove the front flap as described in Chapter 7.5: Installing and Removing the Front Flap.

8.3. Installing in a 19" Industrial Rack Cabinet

Before installing the product in a 19" industrial rack, assemble the slide rails, see Chapter: 7.7: Slide Rails (Option).

The product is designed for horizontal installation in a 19" industrial rack cabinet with the top cover facing upwards. There are no ventilation holes on the top and bottom side of the product, enabling installation directly on top of or below other systems in the 19" industrial rack cabinet.

Ensure the 19" industrial rack cabinet is well ventilated and does not prevent the product from drawing in air at the front and exhausting air at the rear.

⚠ CAUTION

To support the product's weight, two separate fixation methods must be used:

- Front handle brackets (right side and left side)
- Slide rails or L brackets or a 19" rack rear side fixation

⚠ CAUTION

Ensure Sufficient Airflow

Ensure that the 19" Industrial rack cabinet is well ventilated and does not prevent the product from taking in air at the front and exhausting air at the rear.

⚠ CAUTION

The 19" industrial cabinet must be stable. To improve stability:

- Install systems from the bottom up
- Place heavy systems lower down
- Bolt the cabinet to the floor or anchor the cabinet to the wall

⚠ CAUTION

Verify Secure Mounting

In a 19" rack cabinet use two fixation methods: handle brackets (both left and right side) and a second fixation of either slide rails or L-brackets.

⚠ CAUTION

Installing the product alone can result in product damage or personal injury.



Due to possible access restrictions, before installing the product install all expansion card and connect required peripherals to the corresponding system ports.

To install in a 19" industrial rack, proceed as follows

1. Install the slide rails to the product as described in Chapter 7.7: Slide Rails (Option).
2. Install the corresponding rail slide kits to the 19" industrial rack cabinet as shown in Figure 33: Assembling the Slide Rails in an Industrial Rack Cabinet.
3. Push the slide rail assembly into the corresponding slide rail within the 19" industrial rack as far as possible and fasten at the rear of the 19" industrial rack cabinet.
4. Firmly attach the product's handle bracket to the sides of the 19" industrial rack.
5. Verify that the product is securely mounted.

9/ Starting Up

This chapter contains important information on how to connect to a power supply and start the KISS 4U V3 ADL.

9.1. Before Starting

Before starting up observe the instructions within this chapter and refer to Chapter 2/ General Safety Instructions.

⚠ WARNING

Energy hazards-240 VA present in the chassis

To switch off the product properly and ensure no energized internal parts, switch off the product using the power switch on the front side and disconnecting the product's power cable(s) from the input power socket(s) or the mains power supply socket(s).

⚠ WARNING

Easy Access to Power Cable and Power Connectors

The power cable must always remain easily accessible. If the end environment restricts access to power cable, disconnection must be guaranteed using a separate cut-off fixture.

⚠ WARNING

Operate closed

Operate only when the cover is closed and secured, to ensure that operators do not have access to energized internal parts.

⚠ WARNING

Only use the AC power cable delivered with product and sufficiently rated for the implemented power supply.

⚠ WARNING

Ensure that the mains power supply socket (power outlet) is properly grounded and the power cable is in perfect condition with no visible damage.

NOTICE

The rated mains voltage range must agree with the voltage specified on the type label.

9.2. Connecting the Power Supply

The input power socket is located on the rear panel.

Figure 34: Input Power Socket

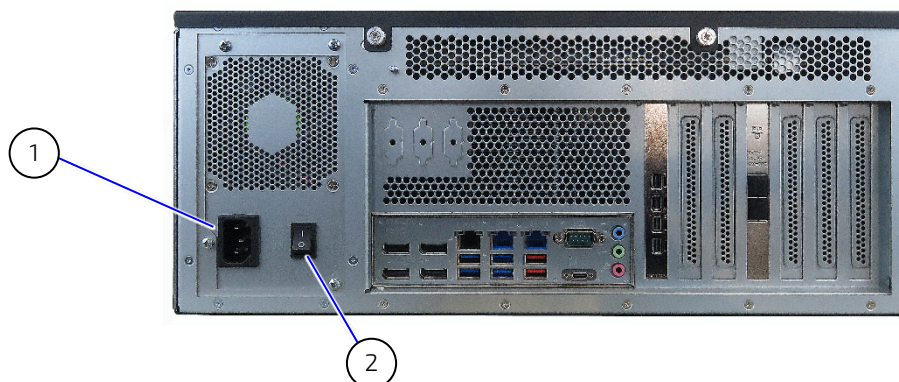

1. Input power socket

2. On/Off PSU switch (single PSU only)

To connect the power, proceed as follows:

1. Connect the ends of the supplied AC power cable (with the correct electrical plug for your region) to the Input power socket (Figure 34, pos. 1) and the mains power supply socket using the electrical plug for the region.
2. Switch the PSU on using the On/Off PSU switch (Figure 34, pos. 2).

NOTICE

**Do not disconnect the power from the product while the product is powered up!
Performing a forced shut down can lead to loss of data or other undesirable effects!**

9.3. Connecting to the Redundant Power Supply (option)

The redundant power supply contains two separate 500 W PSU units where each PSU unit is capable of powering the product alone. Each PSU unit connects, using a dedicated power cable, to the mains power supply. To ensure the power cables are not accidentally removed from the input power sockets, cable clips hold the power connector firmly in place.

If a power supply fails, the faulty power supply shuts down and the functional power supply takes over the full operation, until the faulty power supply is replaced, see Chapter 13.5: Replacing the Faulty Redundant PSU.

Figure 35: Redundant Power Supply

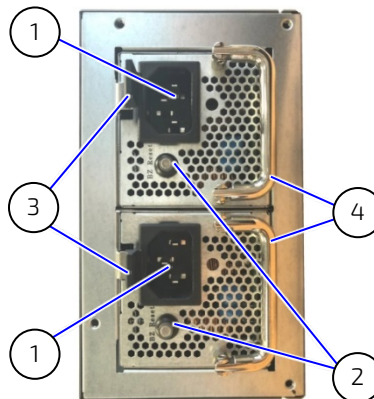

- | | |
|---|-------------------------------------|
| 1. Two redundant input power sockets | 3. Two power cable clip |
| 2. Two buzzer reset switch with indicator LED Power | 4. Two removal and insertion handle |

To connect to a redundant PSU unit, perform the following:

1. Connect both AC power cables (with the correct electrical plug for your region) to the mains power supply socket and input power sockets (Figure 34, pos. 1).
2. Secure the AC power cables to the input power socket using the power cable clip (Figure 35, Pos. 3).

9.4. Switching On

To switch on the product, press the power button (Figure 36, pos. 1) and the power LED (Figure 36, pos. 2) illuminates green to verify the product is active.

Figure 36: Power Button

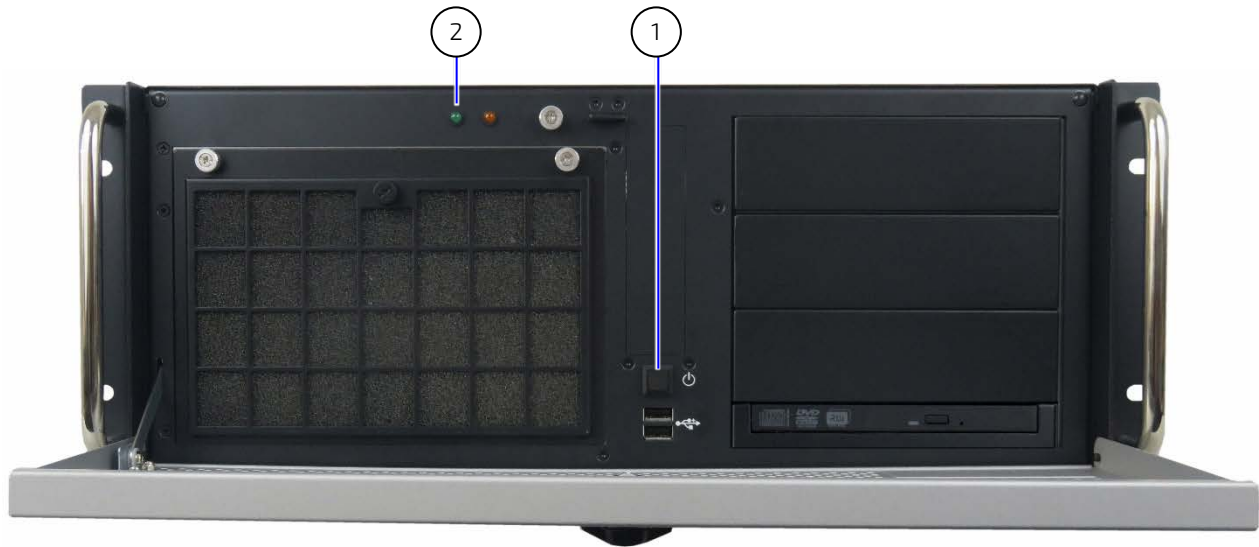

1 Power button

2 Power LED

9.5. Operating System and Hardware Component Drivers

The product is fully operational when switched on for the first time with pre-installed Operating System (OS) Windows 10 IoT x64 or Linux and with all required drivers. For available driver downloads, visit Kontron's [Customer Section Website](#).

If ordered without pre-installed OS, before starting the product install the OS and the appropriate drivers for the system configuration. Consider the manufacturer's specifications for the OS and the integrated hardware components.



To download relevant drivers for the installed hardware, visit Kontron's [Customer Section Website](#).



Pay attention to the installed hardware components manufacturer's OS specification.

10/ BIOS

The KISS 4U V3 ADL uses the uEFI BIOS supported by the motherboard. This chapter informs user how to start, setup, navigate, update and recover the BIOS.



uEFI only! No legacy support and no Master Boot Record (MBR) installation.



Only use the Kontron provided tools!

10.1. Starting the BIOS

To start the uEFI BIOS setup program, perform the following:

1. Power-up the product.
2. Wait until the first characters appear during the Power On Self-Test (POST) messages or splash screen.
3. Press the or <F2> keys during the POST.
4. If the BIOS is password protected, enter the User Password or Supervisor Password, and press <RETURN> to start the BIOS.
5. The BIOS displays the Main setup menu.



If the or <F2> key is not pressed the POST continues with the test routines.

10.2. BIOS Setup Menus

The uEFI BIOS comes with a setup program that provides quick and easy access to the individual function settings for control or modification of the BIOS configuration. The setup program allows for access to various menus that provide functions or access to sub-menus with further specific functions. At the top of the displayed BIOS screen is the menu bar to the setup menus:

- ▶ Main
- ▶ Advanced
- ▶ H/W Monitor
- ▶ Security
- ▶ Boot
- ▶ Exit

To navigate between the setup menus use the BIOS navigation keys described in Chapter 10.3: BIOS Navigation.



Observe that setting wrong values within the Advanced setup menu may cause the product to operate incorrectly.

10.3. BIOS Navigation

The uEFI BIOS uses a hot key navigation system. The hot key legend bar is located at the bottom of the BIOS setup screen and displays a list of keys used to move the cursor and select functions.

Table 11: Navigation Hot Keys in the Legend Bar

Key	Description
<F1>	Displays the 'General Help' window
<->	Selects the next lower value within a field
<+>	Selects the next higher value within a field
<F2>	Loads previous values
<F3>	Loads optimized defaults
<F4>	Saves and Exits
<→> or <←>	Moves cursor left or right to select the setup menu
<↑> or <↓>	Moves cursor up or down to select setup function or sub-screen
<ESC>	Exits a setup menu, enters the Exit setup menu or in a sub-menu enters the higher level menu
<RETURN>	Executes a command or selects a submenu

10.4. BIOS Update

To ensure compatibility with new OS, hardware, software or to integrate new BIOS functions, Kontron recommends regular BIOS updates. Additionally, if a problem cannot be solved using a new driver, Kontron recommends updating the BIOS.

10.5. Updating the BIOS

Before updating the BIOS, Kontron recommends making a backup of the current BIOS setting.



After a BIOS update, additional modifications must be made manually.



After a BIOS update If the product fails to boot, the updated BIOS maybe damaged.

The latest BIOS updates and BIOS release information for the product is available by accessing the Motherboard FTP server on [Kontron's Customer Section Website](#) by selecting **Motherboards & SBC > ATX > K3851-R ATX > Link to the FTP Server**. The FTP server provides operators with downloads of the latest BIOS version and general BIOS information. User can choose the preferred method to update the BIOS and follow the instructions provided.

Figure 37: BIOS FTP Server

Name	Size	Modified	File Download Link
BIOS-Release-Documnt_RaptorLake-S_K3851.pdf	1.3 MB	2023-03-09 14:08:30	Download
K3851-R1.R2.1.0.SetupItemId.txt	5.3 KB	2023-02-08 04:17:32	Download
K3851-R1.R2.1.0.ZIP	27.1 MB	2023-02-08 09:13:18	Download
Previous_Versions	0	2023-06-06 15:28:46	



For the latest BIOS updates and BIOS release information, visit [Kontron's Customer Section Website](#) and select: **Motherboards & SBC > ATX > K3851-R ATX > Link to the FTP Server.**

10.6. Recover BIOS



All BIOS settings and some data is lost during the BIOS recovery process!

To recover BIOS perform the following:

1. Copy the complete content of BIOS ZIP package (K3851-R1.ROM file) to a FAT32 formatted USB drive/stick.
2. Connect the USB stick to the product. Disconnect all other drives
3. Change the recovery jumper to "Recovery position, orange" (Figure 39, pos. 2).
4. After switching on the product, the BIOS bootloader automatically initiates recovery and restores the BIOS contents from the ROM file.
5. System enters a "BIOS setup"-like user interface. Confirm "Proceed with flash update" message.
6. Wait until "Updating main firmware" indicates the success of the recovery procedure.



IMPORTANT: Do not interrupt power or press any key during update!

7. Set the recovery jumper back to the default position (Figure 39, pos. 1).
8. Press any key to reset and check if the BIOS is working properly.
9. Reconnect all drives and switch on the product.
10. Reconfigure the BIOS with your requirements.



If you experience any problems after a BIOS flash, try if "Load Optimized Default Values" (F3) in BIOS Setup solves the problem.

11/Product Specifications

The chapter describes the technical specifications of the KISS 4U V3 ADL.

11.1. Block Diagrams

Figure 38: Block Diagram KISS 4U V3 ADL

KISS 4U V3 ADL

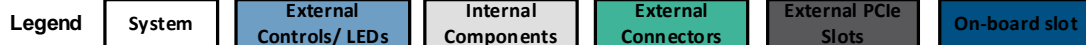
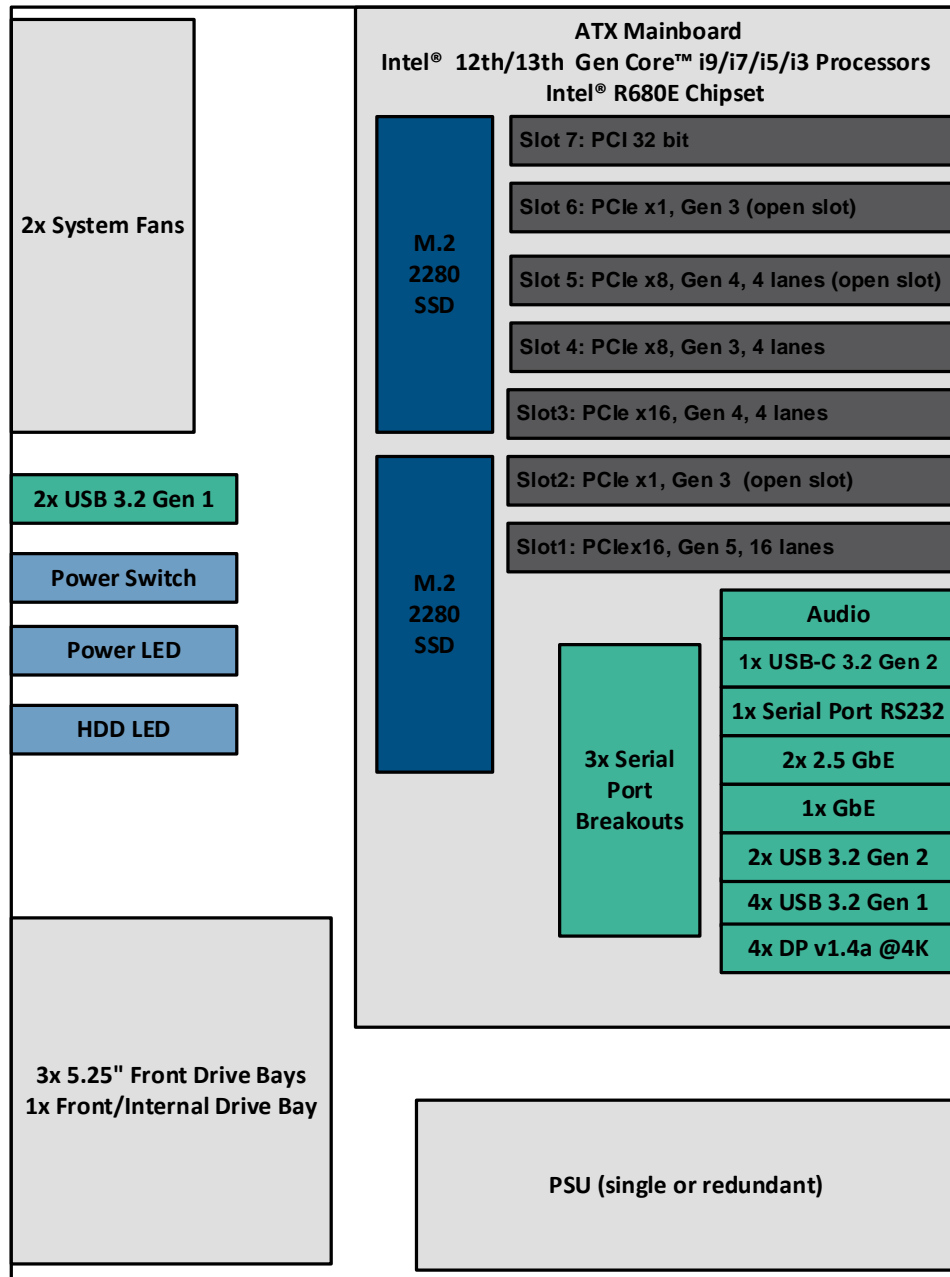

11.2. Hardware Specification

Table 12: Hardware Specification

KISS 4U V3 ADL					
Motherboard					
Type	K3851-R ATX				
Processor Type	Intel® 12 th /13 th Gen Core™, i9, i7, i5 und i3 Processors				
	Processor	Cores	Base Frequency	Turbo Frequency	Base Power
	i9-12900E	16	2.30 GHz	5.00 GHz max.	65 W
	i7-12700E	12	2.10 GHz	4.80 GHz max.	65 W
	i5-12500E	6	2.90 GHz	4.50 GHz max.	65 W
	i3-12100E	4	3.20 GHz	4.20 GHz max.	60 W
	i9-13900E	24	1.8 GHz	5.2 GHz max.	65 W
	i7-13700E	16	1.9 GHz	5.1 GHz max.	65 W
	i5-13500E	14	2.4 GHz	4.6 GHz max.	65 W
i3-13100E	4	3.3 GHz	4.4 GHz max.	65 W	
Chipset	Intel® R680E				
Memory	4x DIMM DDR5-4800, dual channel 128 GByte (max.) Unbuffered, ECC support				
Graphics	Intel® UHD Graphics 770 (i9, i7 und i5) Intel® UHD Graphics 730 (i3)				
M.2 Modules	2x 2280 Key M SSD Interface: NVMe				
Security	TPM V2.0 (Intel® integrated)				
RTC	Onboard RTC				
Front I/O					
USB	2x USB 3.2 Gen 1				
Drive					
Front Accessible	3x 5.25" SATA drive bay				
Internal	1x 3.5" SATA drive bay (for DVD R/W slim drive or internal drive)				
Rear I/O					
USB	4x USB 3.2 Gen 1 2x USB 3.2 Gen 2 1x USB-C 3.2 Gen 2				
LAN	1x 1 GbE (i219LM, with 10/100/1000 Mb/s, iAMT features) 2x 2.5 GbE (i225LM, with 10/100/1000/25000 Mb/s)				
Display	4x DP V1.4a @4K				
Audio	Line in, Line out, Microphone (stereo)				
Serial Port	1x RS232 3x RS232 (option)				
Fans					
System Fan (external)	2x System fans in a removable hot-swap fan assembly				
Fans (internal)	1xPSU (integrated in PSU) 1xCPU (heatsink with fan)				

Expansion Slots	
PCIe/PCI cards (full-height, full-length)	Slot 1: 1x PCIe x16, Gen 5, 16 lanes Slot 2: 1x PCIe x1, Gen 3 (open) Slot 3: 1x PCIe x16, Gen 4, 4 lane Slot 4: 1x PCIe x8, Gen 4, 4 lanes Slot 5: 1x PCIe x8, Gen 3, 4 lanes (open) Slot 6: 1x PCIe x1, Gen 3 (open) Slot 7: 1x PCI 32 bit

11.3. Software Specification

Table 13: Software Specification

Software	Description
BIOS	AMI Aptio 5.x UEFI BIOS
Operating System	Windows 10 64 bit LTSC Linux
Drivers	Necessary drivers provided by the 3rd party device supplier



UEFI only! No legacy support and no Master Boot Record (MBR) installation.

11.4. Power Specification

Before connecting the product to the default 600 W PSU or redundant 500 W PSU, ensure that the power connection meets the required electrical specification for the product. The electrical specification is shown on the type label, see Figure 2: Type Label Example.

Additionally, a redundant 750 W PSU is available on-request.

Table 14: Electrical Specification

	PSU 600 W (default)	PSU 500 W (option)
Type	Single Industrial switching AC/DC	Redundant industrial switching AC/DC
Output Power	600 W	500 W
Input Voltage	100 VAC to 240 VAC (50Hz to 60 Hz)	100 VAC to 240 VAC (50Hz to 60 Hz)
Input Current	8 A max.	8 A max.
Inrush Current	40 A @ 115 VAC 80 A @ 230 VAC	40 A @ 115 VAC 80 A @ 230 VAC

⚠ WARNING

Energy hazards -240 VA present in the chassis

To switch off the product properly and ensure no energized internal parts, switch off the product using the power button on the front panel and disconnecting the product's power cable(s) from the input power socket(s) or the mains power supply socket(s).

⚠ WARNING

Only use the AC power cable delivered with product and sufficiently rated for the implemented power supply.

⚠ WARNING**Easy Access to Power Cable and Power Connectors**

The power cable must always remain easily accessible. If the end environment restricts access to power cable, disconnection must be guaranteed using a separate cut-off fixture.

⚠ WARNING**Operate closed**

Operate only when the cover is closed and secured, to ensure that operators do not have access to energized internal parts.

⚠ WARNING

Ensure that the mains power supply socket is grounded and the power cable is in perfect condition with no visible damage.

NOTICE

The rated mains voltage range must agree with the voltage specified on the type label.

NOTICE

Do not disconnect the power from the product while the product is switched on!
Performing a forced shut down may lead to loss of data or other undesirable effects! Switch off using the power button to perform an orderly shutdown without data loss.

11.5. Environmental Specification

Table 15: Environmental Specification

Temperature		Description
Temperature	Operating	0 °C to +50 °C (+50°F to +122 °F)
	Non-operating	-20°C to +70°C (-4°F to +158°F)
Relative Humidity		10-93 % @ 40° C, non-condensing
Environment		Description
Altitude	Operating	5,000 m (16,400 ft.) Max.
	Non-operating	10,000 m (32,810 ft.) Max.
Shock	Operating	15 g, 11 ms, duration
	Non-operating	30 g, 11 ms, duration
Vibration	Operating	10 – 150 Hz, 1.0 g, 3 axis
	Non-operating	10 – 150 Hz, 2.0 g, 3 axis
MTBF		50,000 @ 30°C (min. configuration)

11.6. Mechanical Specification

Table 16: Mechanical Specification

Dimension	KISS 4U V3 (with front panel & handles)	KISS 4U V3 (without front panel & handles)
Form Factor	4U, 19" rack mount	
Height (4U)	177 mm (6.97")	177 mm (6.97")
Width	482 mm (19")	430 mm (16.93")
Depth	490 mm (19.29")	472 mm (18.58")
Weight	15 kg (approx.)	
Chassis	Chassis: RAL 7021 Front panel: RAL 9022 - standard Front panel: RAL 5017 - option	



For detailed mechanical dimensions, visit Kontron's [Customer Section Website](#).

11.7. Compliance

The KISS 4U V3 ADL plans to comply with the relevant requirements and the approximation of the laws relating to the CE Mark and the standards that are constitutional parts of the declaration.

Table 17: CE Compliance

Europe – CE Mark (Conformité Européenne)		
Directives	2014/30/EU Directive relating to electromagnetic compatibility 2014/35/EU Directive relating to the making available on the market of electrical equipment designed for use within certain voltage limits 2011/65/EU Directive relating to the restriction of the use of certain hazardous substances in electrical and electronic equipment	
EMC	EN 55032 Electromagnetic compatibility of multimedia equipment- Emission Requirements (CISPR 32) EN 61000-3-2 Electromagnetic compatibility (EMC) - Part 3-2: Limits - Limits for harmonic current emissions (equipment input current ≤ 16 A per phase) EN 61000-3-3 Electromagnetic compatibility (EMC) - Part 3-3: Limits - Limitation of voltage changes, voltage fluctuations and flicker in public low-voltage supply systems, for equipment with rated current ≤ 16 A per phase and not subject to conditional connection EN 55035 Information technology equipment- Immunity characteristics (CISPR 35)	

Europe – CE Mark (Conformité Européenne)		
Safety	EN 62368-1 Audio/video, information and communication technology equipment - Part 1: Safety requirements (IEC 62368-1)	

The KISS 4U V3-ADL plans to comply with the following country specific certifications:

Table 18: International Compliance

USA/CANADA		
Safety	UL 62368-1 and CAN/CSA-C22.2 No. 62368-1 Audio/video, information and communication technology equipment - Part 1: Safety requirements	
UKCA (UK Conformity Assessed)		
EMC	EN 55032 Electromagnetic compatibility of multimedia equipment- Emission Requirements EN 61000-6-3 Emission standard for residential, commercial and light-industrial environments EN 55024 Information technology equipment- Immunity characteristics EN 61000-6-2 Immunity for industrial environments	UK CA
Safety	EN 62368-1 Audio/video, information and communication technology equipment - Part 1: Safety requirements	
CB scheme (For International Certifications)		
Safety	IEC 62368-1 Audio/video, information and communication technology equipment - Part 1: Safety requirements (IEC 62368-1)	



If the product is modified, the prerequisites for specific approvals may no longer apply.



Kontron is not responsible for any radio television interference caused by unauthorized modifications of the delivered product or the substitution or attachment of connecting cables and equipment other than those specified by Kontron. The correction of interference caused by unauthorized modification, substitution or attachment is the user's responsibility.



For additional conformity information, visit Kontron's [Customer Section Website](#).

12/ Standard Interfaces- Pin Assignments

12.1. DP Port Pin Assignment

Table 19: DP V1.4a Pin Assignment

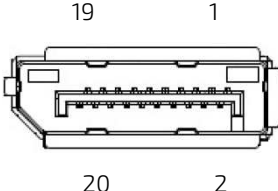
Pin	Signal Name	Pin	Signal Name	DPP (V1.4) Connector
1	Link0+	2	GND	
3	Link0-	4	Link1+	
5	GND	6	Link1-	
7	Link2+	8	GND	
9	Link2-	10	Link3+	
11	GND	12	Link3-	
13	DVI dongle detect	14	CEC (for HDMI)	
15	AUX+	16	GND	
17	AUX-	18	Hotplug detect	
19	GND (Return)	20	+3.3 V ^[1]	

^[1] Fuse protected



All DP output ports are equivalent and support DP++.



Display Port adapters:

- DP to HDMI (passive / active)
- DP to DVI (passive / active)
- DP to VGA (active)

12.2. USB 3.2 Gen 2/1 Pin Assignment



USB 3.2 Gen 2 and USB 3.2 Gen 1 ports are backwards compatible with USB 2.0

Table 20: USB 3.2 Gen 1 Pin Assignment

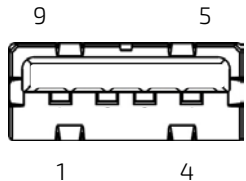
Pin	Signal Name	Pin	Signal Name	USB 3.2 Gen 2 Type A Connector
1	VCC (+5V) ^[1]	5	USB3_RX-	
2	USB2_D-	6	USB3_RX+	
3	USB2_D+	7	GND	
4	GND	8	USB3_TX-	
		9	USB3_TX+	

^[1] fuse protected with a 2 A common fuse, with a Max. current of 900 mA per port

12.3. USB-C 3.2 Gen 2 Port Pin Assignment

Table 21: USB 3.2 Gen 2 Type C Pin Assignment

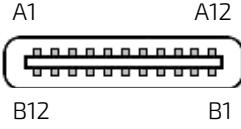
Pin-A	Signal Name	Pin-B	Signal Name	USB 3.2 Gen 2-C Type Connector
1	GND	12	GND	
2	USB3_TX1+	11	USB3_RX+	
3	USB3_TX1-	10	USB3_RX1-	
4	VCC	9	VCC	
5	CC1 ^[1]	8	SBU2 ^[2]	
6	USB2_Data1+	7	USB2_Data2-	
7	USB2_Data1-	6	USB2_Data2+	
8	SBU1 ^[2]	5	CC2 ^[1]	
9	VBUS Power	4	VBUS Power	
10	USB3_RX2-	3	USB3_TX2-	
11	USB3_RX2+	2	USB3_TX2+	
12	GND	1	GND	

^[1] Configuration channel

^[2] Sideband use

12.4. 2.5 GbE/1.0 GbE Pin Assignment

Table 22: LAN (RJ45) Connector Pin Assignment

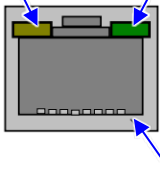
Pin	Signal Name (10/100/1000/2500 Mbps)	Signal Name (10/1000 Mbps)	RJ45 (female) Connector
1	MX1+	TX+	
2	MX1-	TX-	
3	MX2+	RX+	
4	MX3+		
5	MX3-		
6	MX2-	RX-	
7	MX4+		
8	MX4-		

Link/Activity LED		Speed LED	
LED Status	Description	LED Status	Description
Green	Link	Off	100 Mb or 10 Mb
Green Flashing	Activity	Yellow	1.0 GbE
		Green	2.5 GbE



The 2.5 GbE LAN "Activity LED" remain active even if the LAN controller is disabled in the BIOS Setup.



LAN Cabling

1000Base-T CAT 5E/6 or higher up to 100m

100Base-T CAT 5/5E/6 or higher up to 100m

10Base-T CAT 3/4/5/5E/6 or higher up to 100m

12.5. COM Port Pin Assignment

Table 23: RS232 Connector Pin Assignment

Pin	RS232	D89 Connector
1	DCD	
2	RxD	
3	TxD	
4	DTR	
5	GND	
6	DSR	
7	RTS	
8	CTS	
9	RI	

12.6. Audio Jack Connector Pin Assignment (Line-in, Line-out, Mic-in)

Table 24: Audio Jack Pin Assignment

Jack	Position	Signal Name	Signal Name
Blue	Top	Line-in	Line input
Green	Middle	Line-out	Headphone output
Pink	Bottom	Mic-in	Microphone input

12.7. M.2 Key M (NVME SSD) Socket Pin Assignment

Table 25: M.2 Key M Socket Pin Assignment

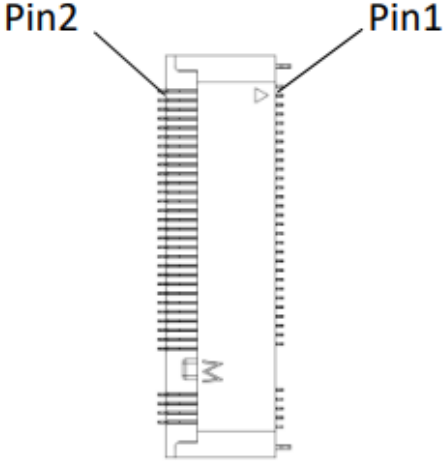
Pin	Signal Name	Pin	Signal Name	M.2 Key M
1	GND	2	+3.3V	
3	GND	4	+3.3V	
5	PCIe RX 3-	6	NC	
7	PCIe RX 3+	8	NC	
9	GND	10	LED SSD	
11	PCIe TX 3-	12	+3.3V	
13	PCIe TX 3+	14	+3.3V	
15	GND	16	+3.3V	
17	PCIe RX 2-	18	+3.3V	
19	PCIe RX 2+	20	NC	
21	GND	22	NC	
23	PCIe TX 2-	24	NC	
25	PCIe TX 2+	26	NC	
27	GND	28	NC	
29	PCIe RX 1-	30	NC	
31	PCIe RX 1+	32	NC	
33	GND	34	NC	
35	PCIe TX 1-	36	NC	
37	PCIe TX 1+	38	NC	
39	GND	40	NC	
41	PCIe RX 0-	42	NC	
43	PCIe RX 0+	44	NC	
45	GND	46	NC	
47	PCIe TX 0-	48	NC	
49	PCIe TX 0+	50	PERST#	
51	GND	52	CLKREQ#	
53	REFCLK-	54	(reserved)	
55	REFCLK+	56	NC	
57	GND	58	NC	
59-65	Key M (no pin)	60-66	Key M (no pin)	
67	NC	68	NC	
69	NC	70	+3.3V	
71	GND	72	+3.3V	
73	GND	74	+3.3V	
75	GND			



Supports PCIe x4 (Gen4) for NVME SSD modules. Mechanical support for 2230, 2242, and 2280 modules. SATA mode is not supported!

12.8. Jumpers

12.8.1. Recover BIOS Jumper

The recover BIOS Jumper is located on the motherboard's front panel header. To recover the BIOS, move the recover BIOS jumper from the default position (Figure 39, pos. 1) to the recover BIOS position (Figure 39, pos. 2) on the front panel header.

Figure 39: Recover BIOS Jumper

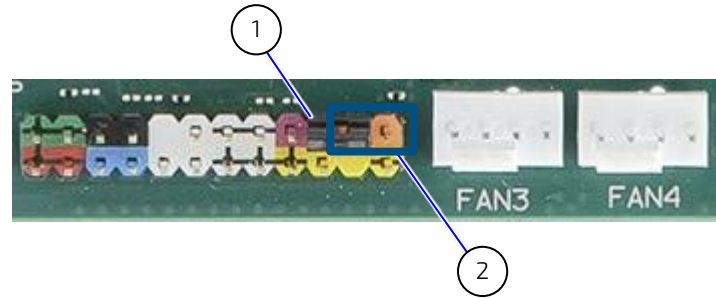

1 Default jumper setting

2 Recover BIOS jumper setting

Table 26: Recover BIOS Jumper

Pins	State	24-pin Front Panel Header
20-22	Default	
22-24	Recover BIOS	



For further motherboard information, visit Kontron's [K3851-R ATX motherboard website](#).

13/ Maintenance and Prevention

Maintenance or repair may only be carried out by Kontron authorized qualified personnel. The KISS 4U V3-ADL only require minimal maintenance and care to keep them operating correctly. Clean the air filter pad regularly (as often as necessary, the time-period will depend on the level of contaminates with in the operating environment).

13.1. Before Maintaining the Product

The product requires only minimal maintenance and care to maintain correct operation. Before maintaining the product, switch off the product properly.

⚠ WARNING

Energy hazards -240 VA present in the chassis

To switch off the product properly and ensure no energized internal parts, switch off the product using the power button on the front panel and disconnecting the product's power cable(s) from the input power socket(s) or the mains power supply socket(s).

13.2. Cleaning the Product

To clean the product wipe the product with a soft dry cloth and if required to remove persistent dirt use a soft, slightly damp cloth (only use a mild detergent).

NOTICE

Do not use steel wool, metallic threads or solvents like abrasives, alcohol, acetone or benzene when cleaning the product.

13.3. Cleaning the Filter Pad

The filter pad is soiled by pollution within the operating environment. To replace the filter pad no tools are required. The filter pad holder on the front side of the fan assembly holds the filter pad in position. Clean the filter pad when clogged with dust or dirt to prevent excessive heating of the product and ensure adequate ventilation. The cleaning frequency depends on the level of contaminates within the operating environment. The filter pad can be changed during operation.

⚠ CAUTION

Clean the air filter pad regularly (as often as necessary, time period will depend on the environment).

⚠ CAUTION

Operation is permitted only with a functional fan assembly!
Replace a defective fan assemble only with an original fan assembly.



The filter pad holder can be fasten to the front side of the fan assembly either before or after the fan assembly is installed in the chassis.

Figure 40: Front Side with Filter Pad Holder

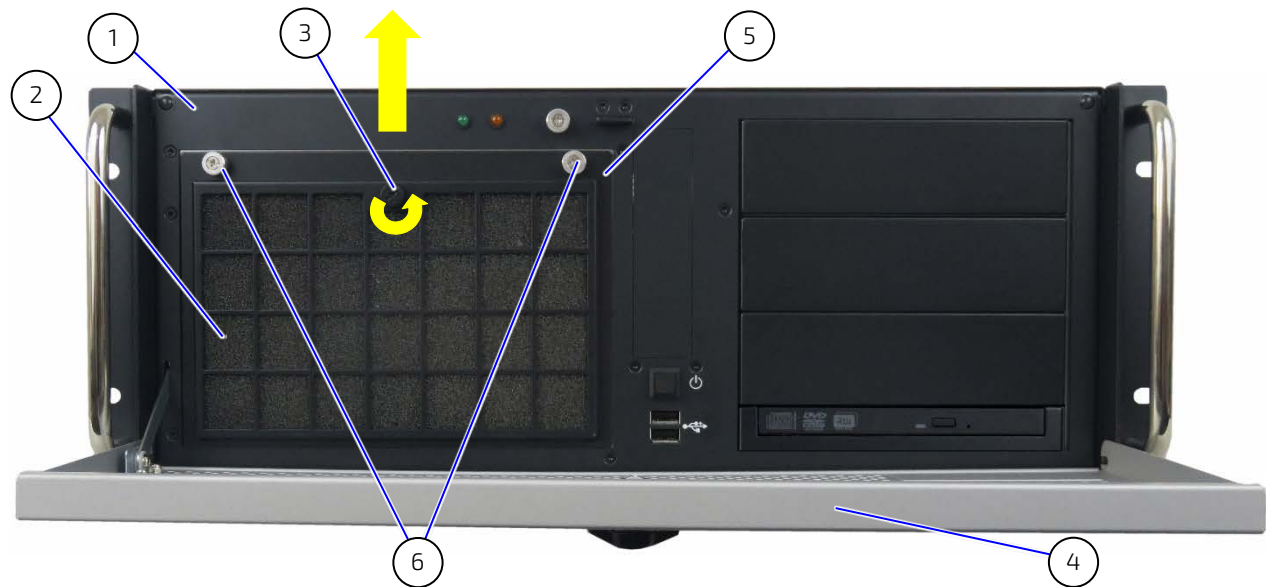

- | | |
|---|--------------------------------------|
| 1. Front side | 4. Front access panel |
| 2. Filter pad | 5. Fan assembly |
| 3. Filter pad holder with knurled screw | 6. Fan assembly's two knurled screws |

To replace the filter pad, proceed as follows:

1. Open the front flap (Figure 40, pos. 4).
2. Loosen the knurled screw that secures the filter pad holder to the fan assembly (Figure 40, pos. 3)
3. Release the filter pad holder's positioning latch from the front side of the fan assembly (Figure 38, pos. 3) by moving upwards and lifting out the filter pad holder.
4. Remove the dirty filter pad (Figure 44) from the filter pad holder (Figure 40).
5. Clean the filter pad as follows:
 - a. Rinse in water (up to approx. 40°C/104°F; with a mild commercial detergent).
 - b. It is also possible to beat the filter pad, suction clean the filter pad or blast the filter pad with warm compressed air.
 - c. If the filter is soiled with grease and dust, rinse the filter pad in warm water with a degreaser
 - d. Do not clean the air filter pad with a piercing jet of water.
6. Do not wring out the filter pad, allow the filter pad to air dry
7. After cleaning and drying the filter pad, place the filter pad in the filter pad holder.
8. Reattach the filter pad holder to the front side of the fan assembly by inserting the filter pad holder's positioning latches (Figure 42, pos. 7) into the fan assembly's positioning holes (Figure 41, pos. 3).
9. Fasten the filter pad holder by tightening the knurled screw (Figure 42, pos. 5) to the bolt with tapped hole (Figure 41, pos. 1) on the fan assembly.

Figure 41: Fan Assemble without Filter Pad Holder

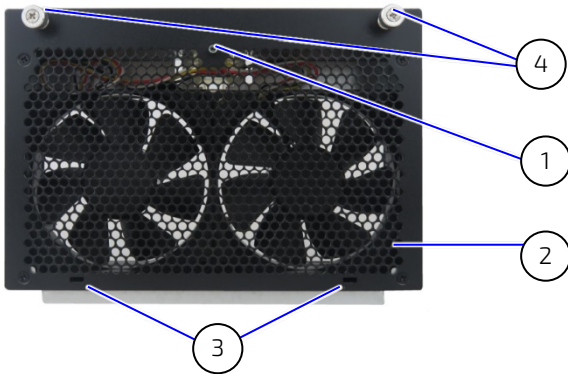

Figure 42: Filter Pad Holder (without filter pad)

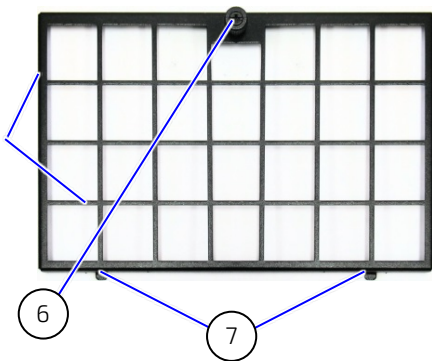
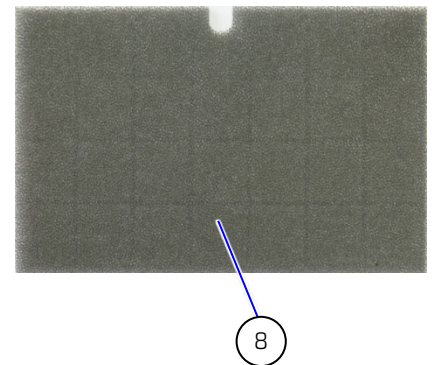

Figure 43: Filter Pad Holder (with filter pad)



Figure 44: Filter Pad



Legend for Figure 41, Figure 42, Figure 43 and Figure 44

- | | |
|--|--|
| 1. Fan assembly bolt with tapped hole | 5. Filter pad holder |
| 2. Ventilation holes (air intake) | 6. Filter pad holder Knurled fastening screw |
| 3. Positioning holes for the filter pad holder | 7. Filter pad holder positioning latches |
| 4. Knurled screws to fix fan assembly to chassis | 8. Filter |

13.4. Replacing the Fan Assembly

Before replacing the fan assembly, read the following instructions:

⚠ CAUTION

Operation is permitted only with a functional fan assembly!
Replace a defective fan assemble only with an original fan assembly.

⚠ CAUTION

Fan assembly replaceable during operation
Replace fan only by qualified specialist or a suitably instructed persons aware of the associated dangers. Before removing the fan assembly, wait until the fans have totally stopped. Keep hands and fingers away from rotating fan parts.



The fan assembly simplifies the installation and removal of the two system fans, and is hot-swappable, enabling the replacement of the fans even during operation.



No tools are required to replace the system fans.

To replace the fan assembly, proceed as follows:

1. Remove the filter pad holder and filter pad as described in the Chapter 13.3: Cleaning the Filter Pad (step 1 to 3). Retain the filter pad holder and filter pad for later use.
2. Loosen the two knurled screws of the fan assembly (Figure 45).
3. Pull the fan assembly slightly upwards to free the fan assembly from the internal fixing plate (Figure 46, pos. 1) and outwards to disconnect the fan assembly connector from the internal fan control socket (Figure 46, pos. 2).
4. Lift the assembly upwards to remove the fan assembly from the fan compartment (Figure 46, pos. 3).

Figure 45: Removing the Fan Assembly



Figure 46: Fan Compartment (without fan assembly)

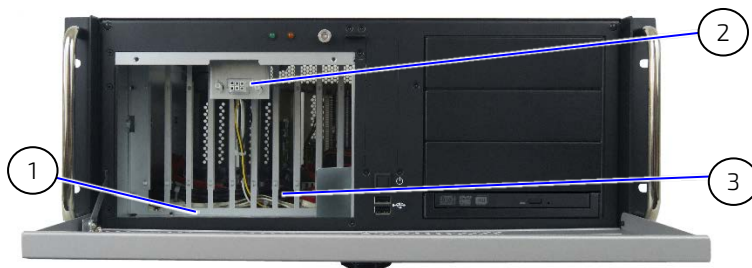

- | | |
|--------------------------------------|--------------------|
| 1. Fixing plate for the fan assembly | 3. Fan compartment |
| 2. Fan power and control socket | |

5. To replace with a new functional fan assembly, align the fan assembly with the fan compartment.
6. Insert the fan assembly's positioning bracket (Figure 11, pos. 5) into the fan compartment's fixing plate (Figure 46, pos. 1).
7. Push the fan assembly carefully into the fan compartment until the fan assembly's control connector (Figure 11, pos. 2) is firmly inserted into the internal fan power and control socket (Figure 46, pos. 2).
8. Secure the fan assembly by fasten the two knurled screws on the fan assembly, as shown in Figure 45.
9. Insert the filter pad into the filter pad holder (both retained in step 1). Then reattach the filter pad holder to the front side of the fan assembly as described in Chapter 13.3: Cleaning the Filter Pad (step 7 to 9).

13.5. Replacing the Faulty Redundant PSU

If one of the PSUs fails, the faulty PSU shuts down and the indication LED changes color from green (active) to red (faulty). The functional PSU takes over the full operation of the product until the faulty PSU is replaced.

⚠ WARNING

AC Power cable

Only use the AC power cable(s) delivered with product and sufficiently rated for the implemented power supply.



The redundant PSU enables hot swap of faulty PSU units.

To replace a faulty redundant PSU unit, proceed as follows:

1. Locate the faulty PSU unit with the red indication LED.
2. Remove the faulty PSU unit's power cable by pushing the cable holder slightly to the side and pulling out the power connector.
3. Pull the faulty PSU unit out using the handle.
4. Insert the replacement PSU unit.
5. Insert the power cable remove in step 2 into the replacement PSU unit's connector until the cable holder clicks to indicate that the cable is firmly in place.
6. Check that the indication LED light is green to indicate active operation.

13.6. Replacing the Lithium Battery

⚠ WARNING

Energy hazards -240 VA present in the chassis

To switch off the product properly and ensure no energized internal parts, switch off the product using the power button on the front panel and disconnecting the product's power cable(s) from the input power socket(s) or the mains power supply socket(s).

⚠ CAUTION

CAUTION: Risk of Explosion if the lithium battery is replaced by an incorrect type. Dispose of used lithium batteries according to the Instructions.

ATTENTION: Risque d'explosion si la pile au lithium est remplacée par une pile de type incorrect. Éliminez les piles au lithium usagées conformément aux instructions.



Do not dispose of lithium batteries in general trash collection. Dispose of the lithium battery according to the local regulations dealing with the disposal of these special materials, (e.g. collecting points for dispose of batteries).

Replaced the lithium battery only with the same type of battery or with a type of battery recommended by Kontron. To replace the factory installed lithium battery (CR2032) on the motherboard, perform the following:

1. Switch off and disconnect the product from the mains power supply.
2. Open the cover, as described in Chapter 7.2: Opening and Closing the Cover.
3. If the product includes expansion cards, first remove the expansion cards and all corresponding connecting cables, to gain access to the lithium battery, see Chapter 7.3: Installing and Removing PCIe/PCI Expansion Cards.
4. Remove the lithium battery from the holder by pulling the ejector spring outwards.
5. Place a new lithium battery in the battery holder while paying attention to the polarity of the battery.
6. Reinstall the removed expansion cards and re-attach the connecting cables,
7. Close the cover, as described in the Chapter 7.2: Opening and Closing the Cover (step 5).

13.7. Replacing a M.2 SSD Module

⚠ WARNING

Energy hazards -240 VA present in the chassis

To switch off the product properly and ensure no energized internal parts, switch off the product using the power button on the front panel and disconnecting the product's power cable(s) from the input power socket(s) or the mains power supply socket(s).

NOTICE

Do not use force when fastening the M.2 screw

Recommended torque for the M.2 screw is 0.2 Nm, and 0.3 Nm for the nut.

Max. torque must not be exceeded, otherwise the motherboard (solder nuts) may be damaged.



After installing or removing a SSD drive, memory partitioning maybe different and require repartitioning.

To replace or exchange a factory installed M.2 SSD module, perform the following:

1. Switch off and disconnect the product properly from the mains power supply.
2. Open the cover, see Chapter 7.2: Opening and Closing the Cover.
3. Locate the corresponding M.2 SSD module.
4. Release the screw fastening the M.2 SSD module to the motherboard. Retain the screw for later user.
5. Removed the M.2 SSD module by carefully holding the sides while pulling the module out of the socket.
6. Insert the new M.2 SSD module by carefully holding the sides of the module and pushing the module into the socket at an angle (approx. 30°).
7. Fasten the M.2 SSD module by pushing down on the module's free end until the module's screw hole aligns with the motherboard and secure with the screw removed in step 4. The recommended torque for the M.2 screw is 0.2 Nm, and 0.3 Nm for the nut. The maximum torque must not be exceeded; otherwise, the motherboard (solder nuts) may be damaged.
8. Close and secure the cover, see Chapter 7.2: Opening and Closing the Cover.

14/ Storage and Transportation

14.1. Storage

If the product is not in use for an extended period time, disconnect the power plug from the mains power source. If it is necessary to store the product, then re-pack the product as originally delivered to avoid damage. The storage facility must meet the products environmental storage requirements as stated within this user guide. Kontron recommends keeping the original packaging material for future storage or warranty shipments.

14.2. Transportation

To ship the product, use the original packaging, designed to withstand impact and adequately protect the product. When packing or unpacking products always take shock and ESD protection into consideration and use an EOS/ESD safe working area.

15/ Technical Support

In order to request technical support, send an email with the information below to support@kontron.com

- ▶ Product name
- ▶ Product model number
- ▶ Serial number of the unit
- ▶ Brief problem description
- ▶ Complete company address

Customers with service portal access may maintain their tickets directly in the service portal.



The serial number can be found on the product's type label.

15.1. Returning Defective Merchandise

All equipment returned to Kontron must have a Return of Material Authorization (RMA) number assigned exclusively by Kontron. Kontron cannot be held responsible for any loss or damage caused to the equipment received without an RMA number. The buyer accepts responsibility for all freight charges for the return of goods to Kontron's designated facility. Kontron will pay the return freight charges back to the buyer's location in the event that the equipment is repaired or replaced within the stipulated warranty period.

Follow these steps before returning any product to Kontron.

1. Visit the RMA Information website:



Kontron's RMA Information website can be found at:

<http://www.kontron.com/support-and-services/support/rma-information>

2. Download the RMA Request sheet for Kontron Europe GmbH, Augsburg and fill out the form. Take care to include a short detailed description of the observed problem or failure and to include the product identification (product name, material number and serial-number). If more than one product is sent in a delivery. Fill out the above information in the RMA Request form for each product.
3. Send the completed RMA-sheet to the given fax or email address at Kontron Europe GmbH. Kontron Europe GmbH will provide an RMA-Number within one business day.
4. The goods for repair shall be packed properly for shipping, considering shock and ESD protection.



Goods returned to Kontron Europe GmbH in non-proper packaging are considered as customer caused faults and cannot be accepted as warranty repairs.

5. Add the RMA-sheet to the relevant delivery address and include the RMA-No with the shipping paperwork.

6. Sent the product to the following delivery address:

Kontron Europe GmbH
RMA Support
Lise-Meitner-Str. 3-5
86156 Augsburg
Germany

Phone: +49 (0) 821 4086-0
Fax: +49 (0) 821 4086 111
Email: service@kontron.com

7. After receiving the product, Kontron Europe GmbH sends a confirmation of the order to the email address named on the RMA sheet.

16/ Warranty

Kontron defines product warranty in accordance with regional warranty definitions. Claims are at Kontron's discretion and limited to the defect being of a material nature. To find out more about the warranty conditions and the defined warranty period for your region, following the steps below:

1. Visit Kontron's Term and Conditions webpage.
<http://www.kontron.com/terms-and-conditions>
2. Click on your region's General Terms and Conditions of Sale.

16.1. Limitation/Exemption from Warranty Obligation

In general, Kontron shall not be required to honor the warranty, even during the warranty period, and shall be exempted from the statutory accident liability obligations in the event of damage caused to the product due to failure to observe the following:

- ▶ General safety instructions for IT equipment within this user guide
- ▶ Warning labels on the product and warning symbols within this user guide
- ▶ Information and hints within this user guide

Additionally, alterations or modifications to the product that are not explicitly approved by Kontron, described in this user guide, or received from Kontron Support as a special handling instruction will void your warranty.

Due to their limited service life, parts that by their nature are subject to a particularly high degree of wear (wearing parts) are excluded from the warranty beyond that provided by law.

Appendix: List of Acronyms

Table 27: List of Acronyms

AMT	Active Management Technology
ATX	Advanced Technology eXtended
BIOS	Basic Input Output System
CLI	Command-Line Interface
COM	Communication port
CPU	Central Processing Unit
DC	Direct Current
DDR	Double Data Rate
DIMM	Dual Inline Memory Module
DP	Display port
DVD	Digital Video Device
DVI	Digital Video Interface
ECC	Error Checking and Correction
EMC	Electromagnetic Compatibility
ESD	ElectroStatic Discharge
GbE	Giga bit Ethernet
GPSD	General Product Safety Directive
GPU	Graphics Processing Unit
HD/HDD	Hard Disk /Drive
HPM	PICMG Hardware Platform Management specification family
iAMT	Intel® Active Management Technology
IOL	IPMI-Over-LAN
IOT	Internet of Things
IPMI	Intelligent Platform Management Interface
KCS	Keyboard Controller Style
KBD	Keyboard
KVM	Keyboard Video Mouse
LAN	Local Area Network
LED	Light-Emitting Diode
LVD	Low Voltage Directive
MEI	Management Engine Interface
NCSI	Network Communications Services Interface
OS	Operating System
PCB	Plastic Circuit Board
PCI	Peripheral Component Interconnect
PCIe	PCI-Express
PECI	Platform Environment Control Interface

PICMG®	PCI Industrial Computer Manufacturers Group
PSU	Power Supply Unit
PXE	Preboot Execution Environment
RAM	Random Access memory
RDIMM	Registered DIMM
REACH	Registration, Evaluation, Authorization and restriction of Chemicals
RMA	Return of Material Authorization
RTC	Real Time Clock
SBC	Single Board Computer
SEL	System Event Log
ShMC	Shelf Management Controller
SMBus	System Management Bus
SMWI	System Monitor Web Interface
SOL	Serial Over LAN
SRAM	Synchronous Dynamic Random Access Memory
SSD	Solid State Drive
SSH	Secure Shell
TPM	Trusted Platform Module
UDIMM	Unregisterd DIMM
UEFI	Unified Extensible Firmware Interface
USB	Universal Serial Bus
WEEE	Waste Electrical and Electronic Equipment
WoL	Wake on LAN



About Kontron

Kontron is a global leader in IoT/Embedded Computing Technology (ECT). Kontron offers individual solutions in the areas of Internet of Things (IoT) and Industry 4.0 through a combined portfolio of hardware, software and services. With its standard and customized products based on highly reliable state-of-the-art technologies, Kontron provides secure and innovative applications for a wide variety of industries. As a result, customers benefit from accelerated time-to-market, lower total cost of ownership, extended product lifecycles and the best fully integrated applications.

For more information, please visit: www.kontron.com



GLOBAL HEADQUARTERS

Kontron EUROPE GmbH

Gutenbergstraße 2
85737 Ismaning
Germany
Tel.: + 49 821 4086-0
Fax: + 49 821 4086-111
info@kontron.com